



Review

Pollutant Emissions in Ports: A Comprehensive Review

Salvatore Barberi ^{1,*}, Mariacrocetta Sambito ², Larysa Neduzha ³ and Alessandro Severino ⁴

¹ School of Engineering and Architecture, University of Enna "Kore", 94100 Enna, Italy

² Department of Engineering, University of Palermo, Viale Delle Scienze, Ed. 8, 90100 Palermo, Italy; mariacrocetta.sambito@unipa.it

³ Department of Theoretical and Structural Mechanics, Dnipro National University of Railway Transport Named after Academician V. Lazaryan, Lazaryan St. 2, 49010 Dnipro, Ukraine; nlorhen@i.ua

⁴ Department of Civil Engineering and Architecture, University of Catania, 95123 Catania, Italy; alessandro.severino@unict.it

* Correspondence: salvatore.barberi@unikore.it

Abstract: In recent decades, maritime transport demand has increased along with world population and global trades. This is associated with higher pollution levels, including the emissions of GHG and other polluting gases. Ports are important elements within maritime transport and contribute themselves to pollutant emissions. This paper aims to offer a comprehensive yet technical review of the latest related technologies, explaining and covering aspects that link ports with emissions, i.e., analyzing, monitoring, assessing, and mitigating emissions in ports. This has been achieved through a robust scientific analysis of very recent and significant research studies, to offer an up-to-date and reliable overview. Results show the correlation between emissions and port infrastructures, and demonstrate how proper interventions can help with reducing pollutant emissions and financial costs as well, in ports and for maritime transportation in general. Besides, this review also wishes to propose new ideas for future research: new future experimental studies might spin-off from it, and perhaps port Authorities might be inspired to experiment and implement dedicated technologies to improve their impact on environment and sustainability.

Keywords: emissions; ports; maritime transport; CO₂; renewable energies



Citation: Barberi, S.; Sambito, M.; Neduzha, L.; Severino, A. Pollutant Emissions in Ports: A Comprehensive Review. *Infrastructures* **2021**, *6*, 114. <https://doi.org/10.3390/infrastructures6080114>

Academic Editors: Reza Haghani, Rami Hawileh and Paolo S. Valvo

Received: 7 July 2021

Accepted: 4 August 2021

Published: 14 August 2021

Publisher's Note: MDPI stays neutral with regard to jurisdictional claims in published maps and institutional affiliations.



Copyright: © 2021 by the authors. Licensee MDPI, Basel, Switzerland. This article is an open access article distributed under the terms and conditions of the Creative Commons Attribution (CC BY) license (<https://creativecommons.org/licenses/by/4.0/>).

1. About This Document and How to Consult It

This review goes through the recent state of art of port emissions, introducing the topic first, and reporting then some of the most relevant technologies to assess and mitigate polluting emissions. This paper will focus on ports, offering a general overview on the subject and aiming to stimulate interest and new ideas for future scientific research. Although the topic requires long-term digressions due to its intrinsic nature (old industry), the chosen reference literature and sources will be as recent as possible. The adopted methodology consists of a systematic and selective review of the latest relevant scientific literature (within the last five years from the current date, and preferably since 2019 whenever available). Section 1 (current) introduces aims and methodology for this study, and it is also meant as a brief technical guide on how to approach and consult this text. After a brief introduction in Section 2 and background digression about the topic in Section 3, the principal types of emissions involved in ports and maritime transport will be described in Section 4. Section 5 will present some of the most recent methodologies designed to estimate, detect, and monitor emissions in ports, mentioning several case studies carried out for different scenarios and geographical locations. Section 6 will list some of the most important systems and technologies aimed to manage maritime emissions focusing on ports and their related maritime transport operations (i.e., hoteling maneuvers). Section 7 will develop a discussion over the subject, also aiming to spark new ideas and inspirations for future research. Eventually, final conclusions will be made in Section 8.

2. Introduction

In the last decades, maritime transport has experienced a rapid and significant increase due to the growth of international trades and commercial demands [1]. Besides, maritime transport is, to date, the most cost-effective transport method for covering long distances and moving large quantities of goods, with ports from all over the world handling the majority of the worldwide trading volume: it is estimated that over 80% of the world's traded goods are transported through maritime shipping [2]. The demand for new ports has hence increased and the existing infrastructure has had to go through development works for expansion; the larger a port becomes, the higher is the correlated risk of pollution due to higher traffics and related operations. Although this aspect can be considered as an indicator of increasing economic wealth, the construction and expansion of ports, along with an increasing demand for maritime transportation, make a significant impact on the environment which cannot be neglected, especially in the current era characterized by deep sensitivity and awareness towards environmental aspects [3]. As an attempt to face environmental risks some ports have already implemented internal policies in order to comply with national and international regulations by containing pollution levels, aiming to reduce emissions, and to implement energy saving measures. In fact, the maritime transport being a business of international breadth due to its intrinsic nature, the implementation of environmental policies should not be confined to single countries on their own, and should involve instead a multitude of cooperating governments within a network of interacting stakeholders [4,5], and as it can be imagined, this is not always easy or even possible. In this sense, one of the motivators to get the interested parties to intervene worldwide, remains perhaps the enhancement of economic and financial benefits for environment-related activities, i.e., tax reductions, grants, and funding, obtained for example once a significant reduction in emissions is demonstrated. It must also be noted that, due to the intrinsic nature of port infrastructures, maritime and coastal pollution can affect different matrices such as air, ground, and water. Energy consumption, or Energy Efficiency to use a more recent terminology, is another environmentally related aspect that should be considered when dealing with ports, not to mention all those other issues connected to CO₂ emissions and climate change. Other forms of pollution also include light pollution, odors, and dust. Besides, ports are often built in proximity of urbanized areas, therefore port pollution can also affect those communities living nearby with risks to human health, especially when associated with other neighboring polluting sources such as production plants, transport hubs, and so on. This being said, it can be helpful to visualize some data showing how the demand for maritime transport has increased through time, and then analyze the relationship with emissions. Figure 1 below [6] shows the relative global commercial shipping density (in red) based on the 11% circa of merchant ships with over-1000 gross tonnage, between 2004 and 2005.

The relationship between the development of global maritime fleets and Greenhouse Gases (GHG) emissions from shipping can be examined with "allometric" models. Allometry can be intended as the disproportional growth relation between two correlated factors, and can be used to describe the disproportional growing relation between expanding maritime fleets and the emission of Greenhouse Gases (GHG). A mathematical model has been elaborated [7] under the hypothesis of not implementing any GHG reduction systems and based on a data set covering the years between 1990 and 2015, contributed by the International Maritime Organization (IMO), the International Council on Clean Transportation (ICCT), and the United Nations Conference on Trade and Development (UNCTD). This growth model calculates a mathematical parameter based on the ratio between the deadweight tonnage of global fleets and the maritime GHG emissions for an assumed time, returning three possible outputs:

- A "positive" allometric result when the parameter is greater than 1; this means that the global fleets' deadweight tonnage grows faster than the GHG emissions.
- A "negative" result when the parameter is lesser than 1, meaning that the global fleets' deadweight tonnage grows slower than the GHG emissions.

- An “isogony” result when the parameter is equal to 1, meaning that the global fleets’ deadweight tonnage grows with a linear proportion law with the GHG emissions.

Eventually, the research study has found that, with the proposed dataset and context, CO₂ and CH₄ shipping emissions comply with a negative allometric law, whereas N₂O emissions comply with a positive allometric law. In the end, it can be said that the topic of emissions in maritime transport is quite broad and complex, and a full coverage would require a multitude of multidisciplinary, long term dedicated projects; additionally, the current amount of very recent, dedicated resources describing the role and behavior of ports towards emissions is at the current moment relatively scarce. Hence, future research studies dedicated to this subject will be appreciated and will have the opportunity to contribute as milestones for this research field. This paper will focus on airborne emissions, aiming to present a general picture on the current state of art in terms of international policies, emission types and sources, recent technologies for emission reduction, and suggestions for possible future research.

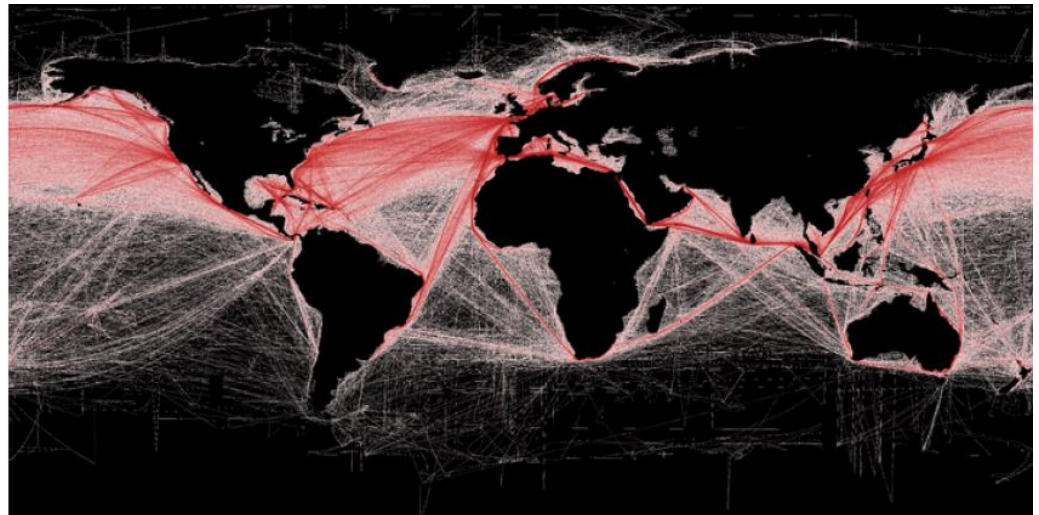

Figure 1. Relative global commercial shipping density based on ~11% of merchant ships > 1000 gross tonnage. Reprinted with permission from ref. [6]. Copyright © 2019 Elsevier Ltd. All rights reserved.

3. Background

Governments and other regulators have developed various policies and administrative instruments in order to manage maritime pollution, aiming for sustainable port operations over the long term. The development of principles and guidelines dedicated to the marine environment has indeed been pursued by several international organizations such as the United Nations Environment Programme (UNEP) in 1972, or the World Commission on Environment and Development (WCED) in 1987, eventually introducing the concept of Sustainable Development and extending it to the related environmental issues. The International Convention for the Prevention of Pollution from Ships (MARPOL 73/78) was developed in the 1970s by IMO as a legal instrument aimed to prevent and contain marine pollution through specific actions undertaken by the 174 adhering countries worldwide. In Europe, most of the IMO rules have been transposed into laws that can be legally enforced within the European waters. Other IMO conventions comprehend the International Convention on the Control of Harmful Anti-fouling Systems on Ships in 2001, and the International Convention for the Control and Management of Ships’ Ballast Water and Sediments in 2004. More recently, organizations such as the European Sea Ports Organization (ESPO) and the World Ports Climate Initiative (WPCI) have produced over the last decades other important outputs such as the ESPO Environmental Code of Practice in 2004 [8], the ESPO Green Guide in 2012, or the C40 World Ports Climate Declaration (WPCI) conference in 2008 [9]. ESPO was created in 1993 with the aim of raising awareness

among European nations and intervening in public policies, in order to make the European port industry safer, more efficient, and more environmentally sustainable. Its Green Guide [10] introduces five actions that ports should undertake to respond to environmental challenges, represented with five words starting with E and therefore known as the “5-Es”; according to the Green Guide, these actions can be briefly summarized as below:

- Exemplifying: Each port should aim to achieve optimum environmental performance, setting a good example for the other ports within the network
- Enabling: Proper operational and infrastructural conditions should be implemented and working, so to enable port users and external elements to access and operate within the port area improving environmental performance
- Encouraging: Incentives should be given to those port users that contribute to improve environmental performance
- Engaging: Port users, authorities and other interested stakeholders should be involved altogether, making them engage with each other to share knowledge and skills, with actions such as participating in common projects in order to chase environmental performance
- Enforcing: Compliance and positive environmental behavior should be enforced through the use of adequate instruments (e.g., fines or surveillance)

EcoPorts is an environmental initiative started in 1997 by the European Port Sector, consisting in a large network of ports collaborating with each other in order to contribute to environmental performance improvement, including the process of monitoring environmental parameters [9]. Since 2011, ESPO has incorporated EcoPorts within its structure. ESPO Environmental Reports, including the latest to date published in 2020, adopt various environmental indicators to assess how ports have reacted to the implementation of the ESPO Environmental Code of Practice. These indicators are distributed into four main categories: Environmental Management, Environmental Monitoring, Top Ten Environmental Priorities, and Green Services to Shipping. Environmental Management Indicators assess elements such as the existence of environmental policies, the definition of environmental objectives and targets for environmental improvement, the definition of environmental training programs for port employees, transparency of information, and so on. It has been observed that in 2020, 96% of European ports were already implementing environmental policies, and 88% had defined objectives and targets for environmental improvement; 69% proceeded with the publication of environmental reports (i.e., transparency) and 55% provided dedicated environmental training for their staff. Moreover, 81% of European ports adopted environmental monitoring programs and 85% documented the environmental responsibilities of their key personnel. Environmental Monitoring Indicators include parameters such as Air Quality, Sediment Quality, Energy Efficiency, Water Quality, Water Consumption, Noise, and so on. It is interesting to note that Air Quality has increased from 2013 to 2020 of +15%, moving from 52% in 2013 to 67% in 2020, with a peak value of 69% in 2018. Carbon Footprint had a +4%, constantly raising from 48% in 2013 to 52% in 2020. Listing the top 10 environmental priorities for European ports in 2020, Air Quality is put at the first place, immediately followed by Climate Change (rising from 10th in 2017 to 2nd in 2020) and then by Energy Efficiency; among other priorities are Noise, Dust, Dredging Operations, and Ship Waste. Green Services to Shipping parameters assess the efforts undertaken by port managing entities in order to pursue greener shipping, and are sub-divided into three smaller categories: provision of Onshore Power Supply (OPS), provision of Liquefied Natural Gas (LNG) bunkering facilities, and Environmentally Differentiated Port Fees [11]. More detailed data are of course available inside the ESPO reports, which are publicly available online, in line with the pursued objective of transparency. In the end, these approaches confirm how regulators are trying to intervene under many diverse aspects, be it either costs or consideration of alternative marine fuel, to tackle marine pollution and environmental challenges. Figure 2 [12] shows the progress and program from IMO to reduce emissions between 2000 and 2020 (EEDI stands for “Energy

Efficiency Design Index”; GHG and SO_x are emission types that will be described in the next paragraph):

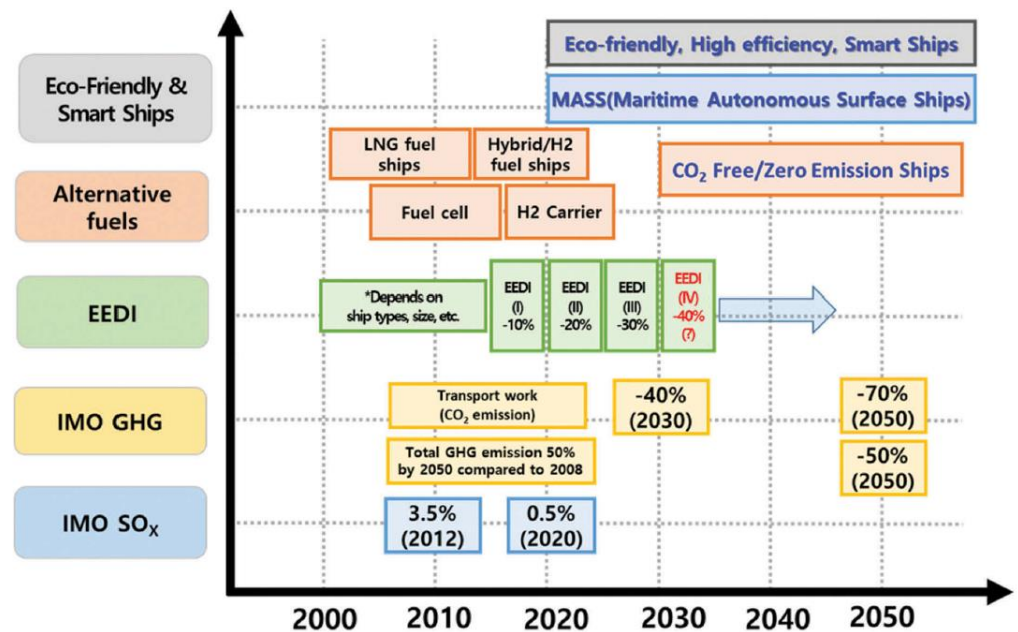

Figure 2. IMO emission reduction program from 2000 to 2050. Reprinted from ref. [12].

It has been assessed that international maritime transport has an impact between 2% to 3% of global GHG emissions, with a predicted increment by up to 50% by 2050. According to the Fourth IMO GHG Study of 2020, GHG emissions from total shipping (i.e., produced by international, domestic, and fishing) has raised from 977 M tonnes in 2012 to 1076 M tonnes in 2018 (9.6% growth), of which 962 M tonnes in 2012 and 1056 M tonnes in 2018 were CO₂ emissions (9.3% growth). Moreover, IMO forecasts predict that emissions will increase by 90 to 130% before 2050 against 2008 values [13]. As a consequence, IMO has been developing specific strategies [12,14] in order to reduce shipping GHG emissions by at least 50% before 2050; besides, the European Commission aims to reduce the GHG emissions generated from European transport as a part of a larger environmental vision called the “European Green Deal” [2]. In order to reduce shipping GHG emissions, IMO has tightened regulations about air pollution in 2010, also introducing special geographical areas where emissions shall be limited more strictly, known as Special Emission Control Areas (ECAs or SECAs). In Europe, these areas are located in the Baltic and Northern Seas. The difference in SO_x and NO_x depositions for 2014 and 2016 for the Baltic Sea region was modelled calculating also the financial impact, to understand what the effects of enforcing Sulphur Emission Regulations (SECA) were in 2015; it has been found that the local SO_x deposition values decreased by 7.3%, with SO_x depositions generated by ships dropping from 38 kt to 3.4 kt, meaning USD 130 M in terms of financial impact on the environment. NO_x depositions have not shown any significant reduction [15]. Figure 3 below shows the geographical extension of ECAs in Baltic and North Seas.



Figure 3. Baltic and North Sea ECAs.

4. Pollutant Emissions in Maritime Transport

An extended literature covering a broad range of diverse scientific fields and industries is already available, describing air emissions and their harmful effects on the environment and human health. Speaking of maritime transportation, however, the range becomes narrower and the amount of available scientific information becomes less abundant, particularly when focusing on the most recent years (although maritime transportation and its emissions should be approached on a long-term perspective). Fortunately, there is still a number of recent studies for emissions in seaborne transport [6] that will support us in understanding the relation between shipping, ports, and emissions [16]. Sources of airborne pollutants can be either natural or anthropic: natural sources include wildfires, volcanoes, and sea spray (ozone), whereas anthropic causes include transportation activities and exhaust gases from engines [17]. With an extreme attempt to simplification, it can be said that there are two main categories of maritime polluting emissions: Common Air Contaminants (CAC) and Greenhouse Gases (GHG), plus an additional group if we want to consider other forms of less aggressive pollutants such as dust, smoke, odors, and even noise [18]. Chemical substances such as PM_x, Sulphur, and Nitrogen Oxides can have direct harmful effects on the environment (including human health), whereas CO₂ and other greenhouse emissions strongly contribute to global warming and climate change. Table 1 below lists some of the main pollutant substances for these categories:

Table 1. General classification of air pollutants.

Type	Main Pollutants
Common Air Contaminants (CAC)	Oxides of Nitrogen (NO _x) Oxides of Sulphur (SO _x) Particulate Matter (PM ₁₀ and PM _{2.5}) Carbon Monoxide (CO) Volatile Organic Compounds (VOC) Ozone (O ₃)
Greenhouse Gases (GHG)	Carbon dioxide (CO ₂) Methane (CH ₄) Nitrous Oxide (N ₂ O)
Other pollutants	Dust Odors (Noise)

4.1. Greenhouse Gases (GHG)

Greenhouse Gases (GHG) are already present in the atmosphere, capable of capturing a considerable share of the thermal infrared radiation emitted from the Sun and reflected from Earth; this property leads to the well-known “Greenhouse Effect”: since these gases absorb thermal energy, the atmospheric temperature rises, creating the necessary favorable conditions for life on Earth. The Greenhouse Effect itself is therefore a natural phenomenon, and GHG are normally emitted from natural sources such as for example CO₂ produced through chlorophyll photosynthesis of plants. The increase in CO₂ emissions beyond the normally sustainable natural values, as a consequence to anthropogenic activities such as transport, can cause the temperature in the atmosphere to rise too much, aggravating the Greenhouse Effect and contributing to Global Warming [19]. As stated in [20], according to the International Energy Agency (IEA) China has emitted over 10 billion tons in total carbon emissions between 2017 and 2019, 10% of which are attributable to transportation activities. The impact from the transportation industry to GHG emissions (particularly CO₂) is indeed one of the most relevant, with the related CO₂ emissions rising by 45% between 1990 and 2007 and expected to rise by a further 40% by 2030 [21]. According to [22], total maritime GHG emissions (including CO₂, CH₄, and N₂O, and expressed in CO₂ equivalent emissions or CO₂e) have increased from 977 million tonnes in 2012 to 1076 million tonnes in 2018 (9.6%), with CO₂ constituting near the 98% of them. In addition to the environmental benefits, reducing GHG emissions also translates into financial advantages, as it has been demonstrated that replacing internal combustion vehicles with electric or hybrid ones would lead to generating USD 760 million a year, in addition to USD 2091 million from correlated health benefits, for a total amount of USD 2851 million [23]. Figure 4 schematizes the Greenhouse Effect [24].

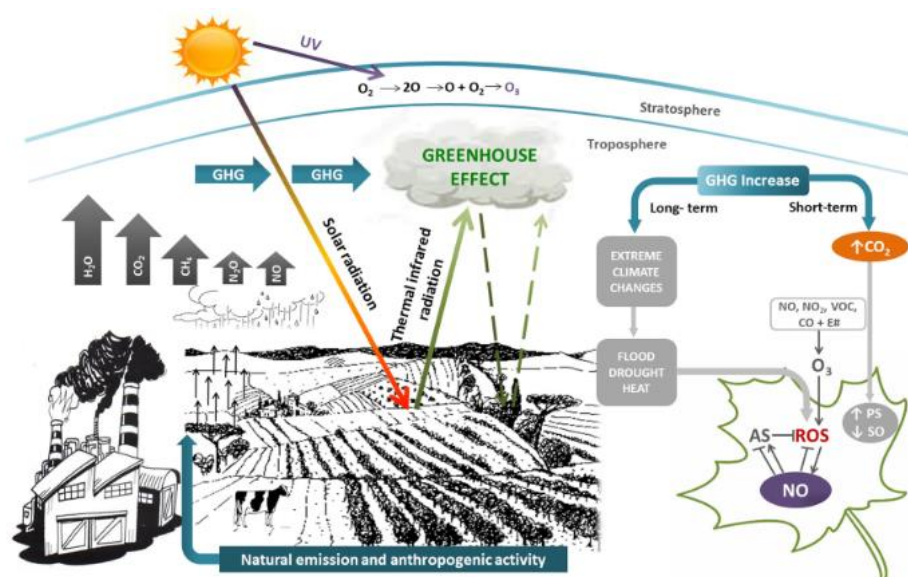

Figure 4. The Greenhouse Effect explained. Reprinted from ref. [24].

4.2. Common Air Contaminants (CAC)

Marine fuels are considered as the most important cause of high NO_x (Oxides of Nitrogen) emissions in shipping, with a significant amount of emissions especially if compared with other transport systems such as road transport (i.e., considering also vehicles inside ports). Oxides of Nitrogen are generated inside cylinders due to high pressures and temperatures, leading to oxidation of nitrogen with oxygen, both present in the air [25]. SO_x (Oxides of Sulphur) comprehend a family of different chemical compounds characterized by the presence of Sulphur and Oxygen. In nature, these emissions are typically produced by volcanoes. They have harmful effects on the human body, as they stimulate nasal and throat nerves causing respiratory problems especially in asthmatic

individuals [26]. In maritime transportation, SO_x emissions mainly originate from the combustion of marine fossil fuels, with SO₂ being the most predominant produced oxide. Considered local and global pollutants at the same time, SO_x emissions are dangerous to health because they can provoke respiratory problems; moreover, SO_x gases can react with oxygen in presence of NO₂ resulting in sulfuric acid, which can eventually damage the environment through acid rains. SO_x gases can raise the eutrophication potential, and can also bring a cooling effect on the temperature and consequently to climate change [25]. Other forms of fuel combustion by-products that constitute polluting threats include Volatile Organic Compounds (VOC) [27,28] and Particulate Matter (PM) [29]; the latter consist in fine aerosol particles classified by their diameter size, from which PMs are further labeled into PM₁₀ and PM_{2.5} if diameter $d \leq 10 \mu\text{m}$ and $2.5 \mu\text{m}$, respectively. CACs contribute to the formation of photochemical smog, in particular NO₂ as a precursor to tropospheric ozone (O₃); CAC also contribute to the phenomenon of “acid rains” through the transformation of NO₂ into nitric acid [30]. High concentrations of CAC can lead to breathing problems especially on those who are already affected by respiratory diseases and illnesses such as asthma; moreover, CACS are also harmful by undermining the immune system, weakening the human body’s natural ability to defend itself against bacteria and viruses [31]. Studies in literature show the correlation between CAC emissions and diseases [32] such as bronchitis and asthma [33] and even with premature deaths, with over 400,000 premature deaths associated with PM_{2.5} and NO_x across the 28 EU countries in 2016 [34]. The latest MARPOL indications set the SO_x and PMs acceptable limits to 0.1% for ECAs, and from 3.5% to 0.5% for areas outside ECAs. Eventually, IMO has banned the carriage of non-compliant fuel on board for those ships not equipped with scrubbers (or exhaust cleaning systems) from March 2020. IMO has indicated further thresholds and multiple solutions to pursue the reduction of CAC, many of which are reported in this paper. Figure 5 reports the effects of air pollutants on human health [35].

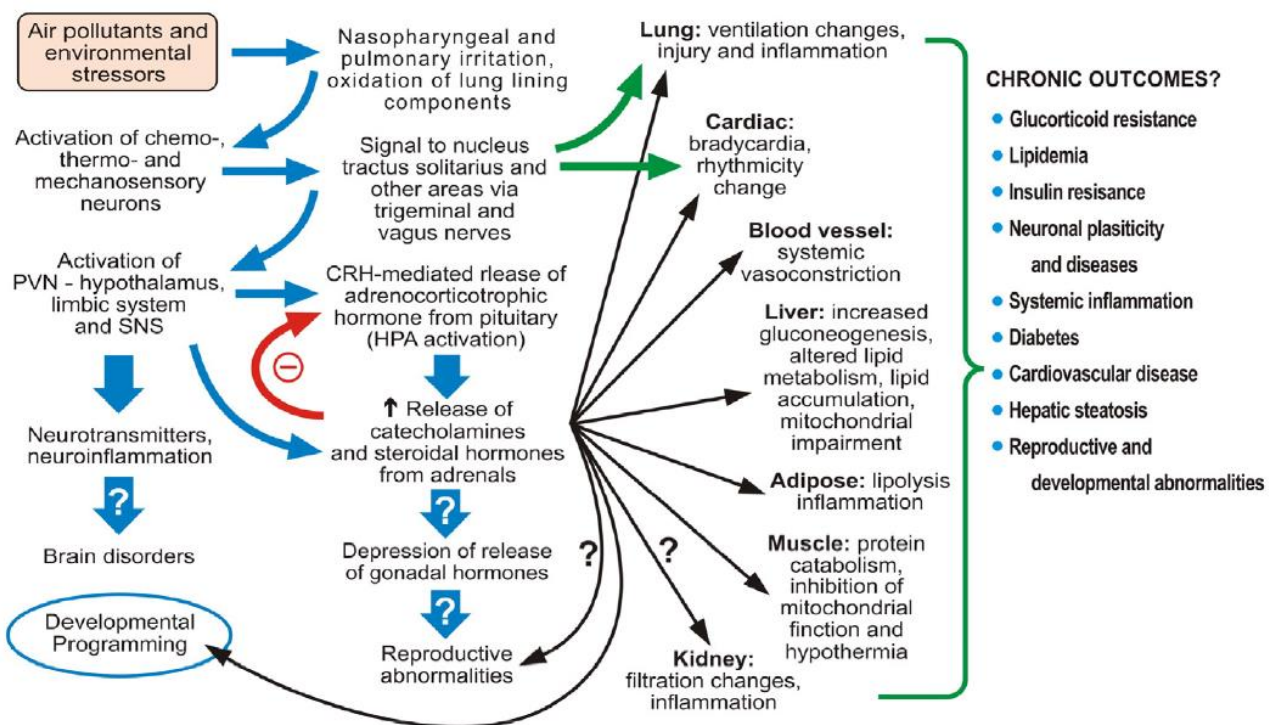

Figure 5. Effects of particulate matter on different components of the atmosphere. Reprinted with permission from ref. [35]. Published by Elsevier B.V. Copyright © 2016 Elsevier Ltd. All rights reserved.

4.3. Other Airborne Pollutants

Although dust and odors can constitute a hazard threatening human health and the environment, authors believe that in the case of ports their contribution is generally low enough and will not be discussed in this paper. Sandstorms may constitute a serious safety and operational problem in dry areas that are frequently affected by this phenomenon, however they will not be strictly considered as a form of pollution and will not be treated here either. In addition, noise, an often understated form of pollution, can cause some relevant discomfort to people working and living by ports in the long term, leading even to hearing disturbances and hearing loss in the worst scenarios; however, the deepening of this subject would require an extensive study about acoustics, construction techniques and mechanical engineering which will not be undertaken here, as the authors wish to focus their attention on CAC and GHG in this article.

5. Estimating, Detecting, and Monitoring Emissions in Ports

Ports are an ensemble of pollution sources, from their construction phase to their full operation state, considering for example the use of environmentally hazardous materials for construction and their disposal, the use of industrial equipment and machinery, or the emissions produced by ships (usually propelled by diesel engines) [36]. A typical port layout comprehends areas dedicated to diverse functions, spacing from offices, warehouses and storage yards, parking spaces, intermodal hub infrastructures, passenger buildings, and piers and quays; all of these facilities can be seen as potential sources of pollution, considering elements such as emissions from ships, cars, and other means of transport, or the presence of large Heating Ventilation and Air Conditioning (HVAC) systems. Indeed, emission sources can be organized into two large groups: the first including stationary sources such as warehouses, mechanical plants, offices, etc., and the latter including mobile sources such as ships, cranes, vehicles, and so on [37]. Hence, the assessment of the emissions level for ports must also take into account the combined contribution of various internal polluting agents, but also the potential interaction with external nearby sources such as factories, urban areas, busy highways, and so on, not to mention weather conditions (i.e., wind, rain) [38,39]. Moreover, since ports are built to last for an extended lifetime, their impact on the environment can be long lasting and estimating emissions should also consider a long-term approach [40]. Estimating emissions in ports can indeed be a complex process, especially when mathematical models and computer algorithms need to take all these variables into account. Additionally, it must be specified that each port in the world has different sizes and functions due to their specific business environment: therefore, direct comparisons are not really feasible; each case is unique, and any adaptation to other infrastructure will inevitably require reassessments and adjustments. Finally, other potential issues consist in the scarcity and unavailability of relevant scientific data, and use of resources such as high computing power necessary to develop and run simulation models [41]. A study undertaken in China envisages the use of aerial drones, also known as Unmanned Aerial Vehicles (UAVs), for detecting emissions in ports [42]; this is an example of how the most recent technology can be exploited for environmental purposes such as the monitoring of emissions. Since the UAV technology is relatively recent, and being its application for air emission detection at a very early stage, it needs to be refined solving problems connected to path planning, air traffic control, accuracy, and so on. On the other hand, this seems to be a promising technology, as it would avoid human exposure to emissions during monitoring operations, since UAVs are fully automated. The study hereby mentioned proposes a mathematical model and computer algorithm aimed to operate multiple UAVs, so as to detect air emissions from ships in ports in real time. An additional benefit is that through the proposed algorithms it is possible to program UAVs to follow pre-planned paths, and to direct them toward those ships that involve less detection costs and higher detection efficiency. Figure 6 reports an output chart showing one of the UAVs flight paths considering cost and efficiency; red dots symbolize ships to be detected, while blue triangles represent UAVs.

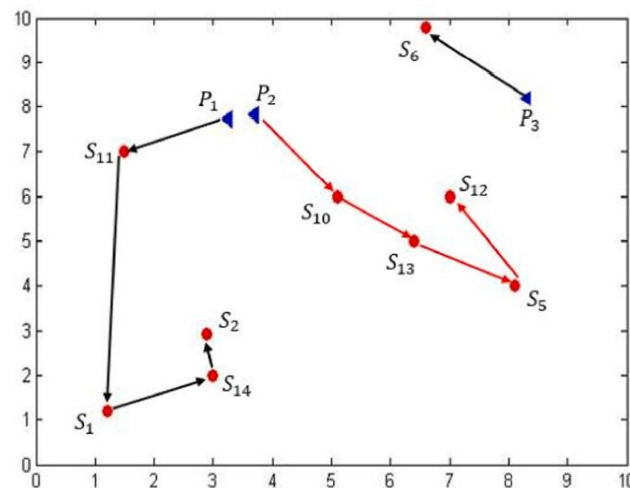

Figure 6. UAVs flight path chart considering cost and efficiency. Reprinted with permission from ref. [42]. Published by Elsevier B.V. Copyright © 2020 Elsevier Ltd. All rights reserved.

An ensemble of case studies will be reported below to offer an idea of the possible ways to estimate emissions in ports, considering also their interaction with the surrounding environment. Despite their commercial relevance, the following sample ports might not currently hold a leadership position in terms of environmental practices; however, authors see this as an evidence of the ever-increasing interest towards the environment and sustainability among other ports. The selected ports are located in the Mediterranean Sea, and have been chosen as the authors desire to focus on this area planning to proceed with future research for other ports in the Mediterranean and Black Sea, where the scenarios could be slightly similar. It must be specified, however and as already mentioned before, that each port is unique, and the following cases should not be directly compared with each other nor directly applied to other contexts, but rather seen as different attempts to face the emission problem in ports. Although they could constitute a starting point for similar scenarios, reassessments and more or less heavy adjustments will inevitably be necessary.

5.1. Port of Volos, Greece (2018)

Road traffic interacting with ports can be made of vehicles used for both private and commercial activities. Particularly, trucks are used to transport goods from large warehouses and storage centers to external destinations scattered across extended areas for retail trade, eventually employing smaller light vehicles to reach minor sites in a capillary network. Since ports can be considered as large storage areas and multimodal transport exchange points, container trucks and Heavy Goods Vehicles (HGVs) are frequently involved with the commercial activities revolving around harbors, contributing to traffic volumes as they move in and out from ports. Port employees or passengers may have to access and exit the port with their own vehicles as well. A research study conducted in 2018 has assessed the effects deriving from the application of specific traffic and logistic measures applied to the port of Volos (Greece), examining the relation between port operations with the transportation of containers and bulk shipments on the road network connected to the port. This has been done through a mathematical model obtained by the integration of two different simulation software with each other: AnyLogic and VISSIM [43]. The assessment has considered traffic data for a weekday in June, a day representing typical traffic conditions, and has been performed for two different circumstances: a base scenario with no measures implemented, and a scenario with specific measures implemented instead. Measures were chosen according to three key criteria: Soft measures (no structural interventions), Intelligent Transport Systems (ITS) oriented, and low-cost implementation; these measures were eventually implemented into the models by adjusting some parameters for calibration:

- Real time online system for better monitoring: trucks can transport greater amounts of bulk shipments by increasing the HGVs load factor; this optimization can be achieved through the use of real-time online smart systems that communicate info about remaining shipment volumes, unexpected events, etc. This implementation can lead to an increase in HGV load factors up to 95%
- Green Fleet: increase the number of HGVs powered by alternative fuels, increasing Compressed Natural Gas vehicles from 2% to 4% and Electric vehicles from 20% to 23%, while reducing the number of diesel-powered HGVs from 78% to 73%
- Local Traffic Management: implementation of Intelligent Transport Systems for traffic management and control, such as intervening on the timing of intersection signals; this leads to optimizing the acceleration and deceleration maneuvers for HGVs, therefore improving the traffic flow and allowing reduced noise, used fuel, and emissions.

The study demonstrated that three calculated environmental indicators describing levels of CO₂, NO_x, and PM₁₀ showed lower values by circa 7% to 9% in favor of the second scenario (where transport management measures had been implemented), and one transport-related indicator representing the sum of delays was 26% lower as well. The Logistics Sustainability Index (LSI), a comprehensive index summarizing the other indicators has been calculated with a multi-criteria decision-making tool; a raise in LSI means a general improvement of the system, and in this case, LSI had an increase of circa 21%. Figure 7 summarizes this info; more detailed data are available in the original study. Generally speaking, it can be said that a proper optimization of the road traffic interacting with ports, thanks to the application of mathematical and computer models, can lead to a significant reduction in emissions.

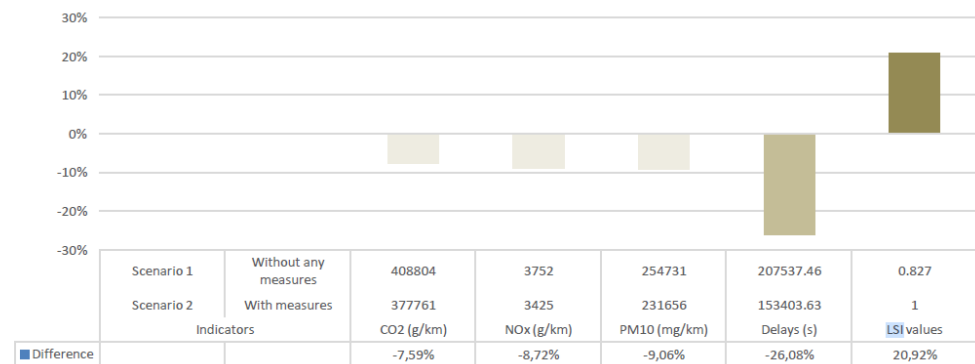

Figure 7. Percentage variation of environmental, delay, and LSI indicators. Reprinted from ref. [43].

5.2. Port of Barcelona, Spain (2020)

A case study for the Port of Barcelona carried out in 2020 [44] can be seen as another example of interaction between the port area and the surrounding environment. This study has shown an improvement in terms of emissions after the application of green initiatives, within a number of 53 programs grouped into 7 categories, defined by the Port of Barcelona. These seven categories are an example of what can be done to improve the environmental performance in ports, and for reference they will be listed below:

- Investments into new infrastructure to encourage the use of alternative fuels (e.g., LNG);
- Provision of electric connection for marine vessels;
- Price discounts and port charge reductions as an incentive for virtuous shipping companies that improve environmental performance;
- Replacement of diesel-powered land vehicles with electric or natural gas;
- Electrification and gasification of port terminal machinery;
- Investments in better infrastructure to improve the use of rail and Short Sea Shipping (SSS) to reduce road transportation and traffic;
- Enhancement of collaboration with port customers and other external stakeholders to promote sustainable mobility.

To assess the port emission activity, data for NO₂, SO₂, and PM, related to maritime and road transport have been collected from surveying stations scattered all over the city of Barcelona and in general across the urbanized area surrounding the port. The study presents a correlation between port activities, their interaction with the surrounding environment, and the correlated effects in terms of emissions, demonstrating also that actions such as the introduction of intermodal means of transport, the improvement of rail facilities, and the implementation of adequate policies has led to positive effects on reducing emissions over few years. Figure 8 below shows the area of study, whereas Figure 9 shows as an example the overall decreasing trend of PM_{2.5} emissions between 2007 and 2017.

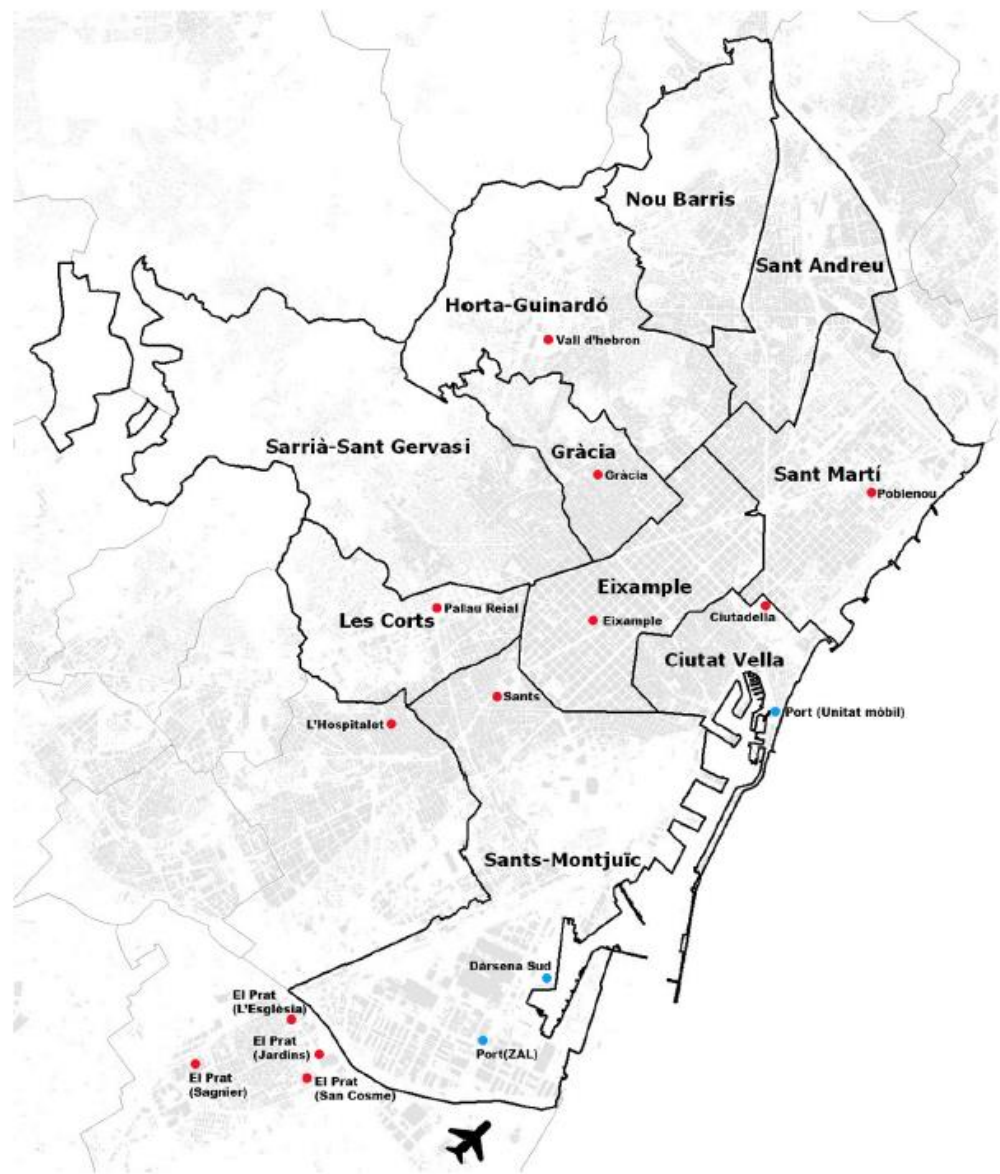

Figure 8. Area of study around the port of Barcelona. Reprinted with permission from ref. [44]. Copyright © 2020 Elsevier Ltd. All rights reserved.

5.3. Port of Bari, Italy (2019)

An example of estimation model showing the interaction with the surrounding environment of a port has been developed for a research study, which was implemented as a pilot test into the IT and Management software of the port of Bari in Italy. Emission data were collected through a network of low-cost sensors connected to the internet and then

integrated with a local scale dispersion model. This system can operate in three different modalities: near-real-time, forecast mode, and on archived data for long term assessments. Other emissions from different sources such as port vehicles and port cranes were calculated with mathematical equations, referring to year 2018 data. For this case, results showed that the city of Bari is not strongly affected by port generated emissions. Ships had an impact in terms of PMs of between 44% and 97% within the entire harbor pollution (total PMs impacted for 11.8%) and of up to 80% in terms of CO₂ (largest impact). Impact on NO_x levels ranged between a few percent above the urban area up to 40% within the port, while CO varied between 8% and 68% [45]. Figure 10 shows the area where sensors were installed, while Figure 11 shows the dispersion of NO_x emissions through air around the port: it can be noted how in this case emissions are not interfering with the nearby urban area; other similar maps for different pollutants are available inside the research study. This study is an example of monitoring emissions in ports and highlights the fact that surrounding elements such as cities or industrial areas must be kept in consideration when assessing or monitoring emissions in ports. In this sense, in addition to the technical improvement of monitors and other devices, particular attention must be dedicated to the area of study, considering both human activities and geographical features, so to obtain more accurate information and choose the most appropriate interventions.

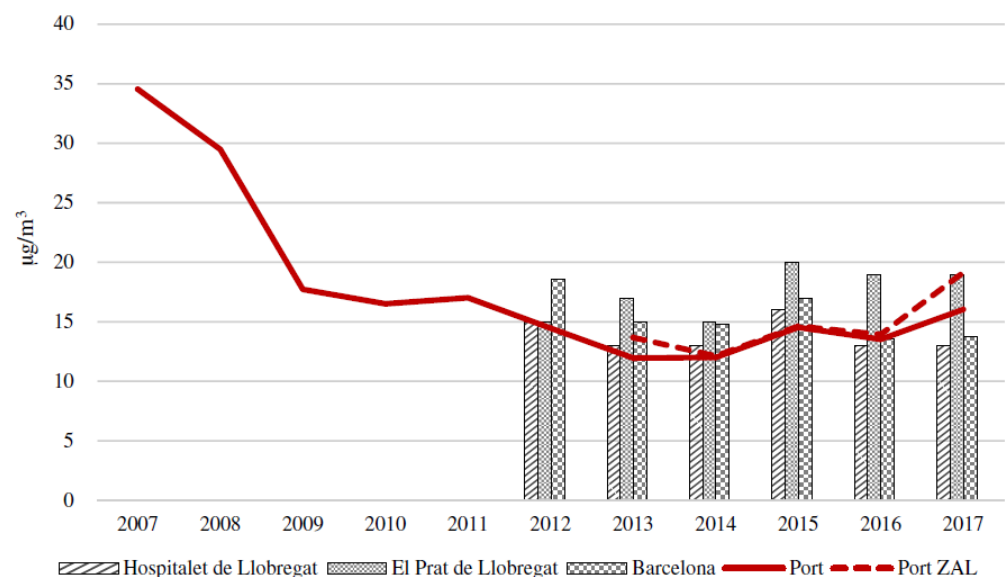

Figure 9. Annual mean of PM_{2.5} emissions between 2007 and 2017, showing an overall decreasing trend. Reprinted with permission from ref. [44]. Copyright © 2020 Elsevier Ltd. All rights reserved.

5.4. Port of Piraeus, Greece (2021)

A research study for the greater area of Piraeus Port (Greece) has been carried out in order to estimate the port impact in terms of emissions [46]. The most relevant source of emissions consisted in ship engines due to the combustion of fossil fuels, and adds up with other sources present in the port surroundings. Emissions are also produced by Cargo Handling Equipment (CHE) used for container operations, and by land vehicles entering and leaving the port, whereas cranes in Piraeus Port are electrically powered and therefore not a source of emissions. CHE include straddle carriers, whose emissions were modeled in this study through a methodology developed by the European Monitoring Evaluation Programme/European Environmental Agency (EMEP/EEA) [47], and heavy duty vehicles, whose emissions were modeled with a COPERT V Tier 3 model; furthermore, COPERT Tier 3 was used to simulate emissions generated from port internal and peripheral road traffic. The EMEP/EEA Air Pollutant Emission Inventory Guidebook 2019 (updated in 2020) is a technical document that describes procedures to estimate emissions for the shipping transport with dedicated mathematical models and algorithms. COPERT is a simulation

model recognized and approved by the European Environmental Agency, and widely used worldwide, including the Greek Ministry of Environment and Energy. In this case, port emissions for each vessel and pollutant are calculated with Equations (1) and (2):

$$E_i = E_{maneuvering} + E_{hoteling}, \tag{1}$$

$$E_i = \sum_p \left[T_p \sum_e (P_e * LF_e * EF_{e,i,j,m,p}) \right], \tag{2}$$

where:

- E_i = total amount of ship emissions for a specific pollutant i ;
- p = phase of activity (hoteling, maneuvering);
- m = fuel type;
- j = engine type;
- e = engine category (main, auxiliary);
- T = time spent at each activity phase h ;
- P = engine nominal power (in kW);
- LF = engine load factor (in %);
- EF = emission factor for the type of vessel and pollutant (in kg/kWh).

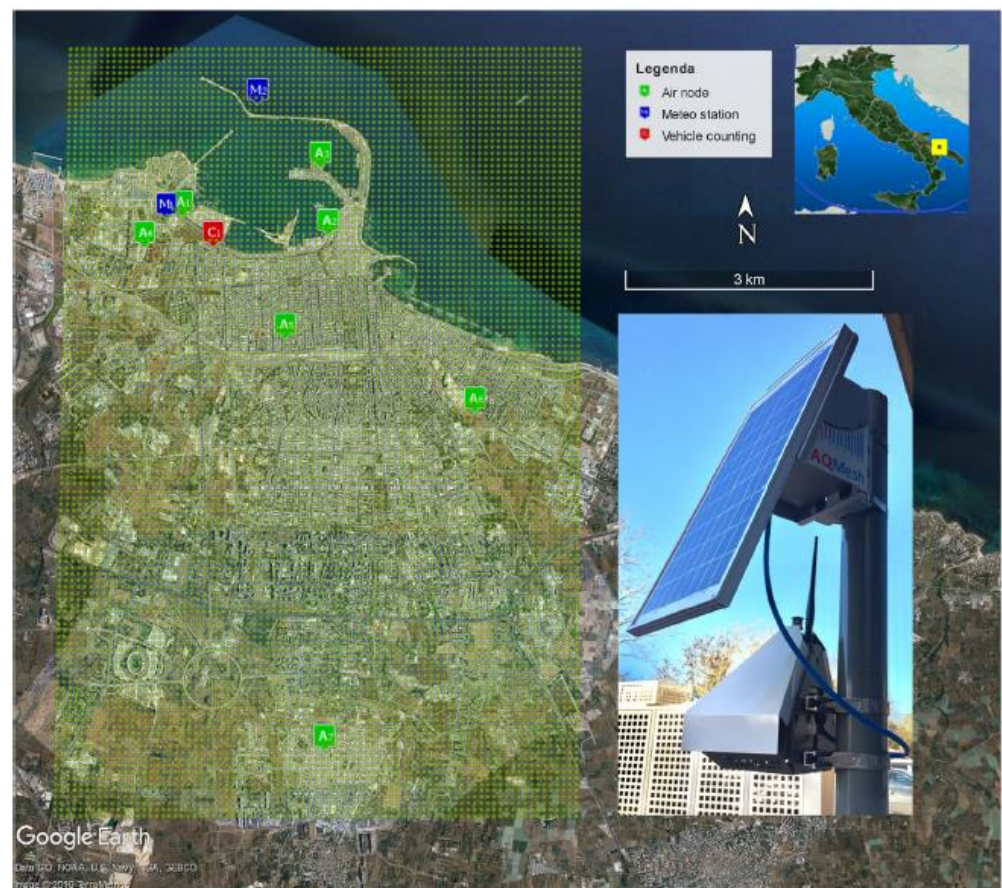

Figure 10. Area of analysis reporting the location of monitoring sensors, the position of Bari in Italy (upper right box), and a typical sensor (lower right box). Reprinted with permission from ref. [45]. Copyright © 2019 Elsevier Ltd. All rights reserved.

The external costs were calculated based on the Handbook on External Costs of Transport [48] published by the Directorate-General for Mobility and Transport, considering cost factors for air pollution to health and other environmental effects, with few adaptations to take into account the most recent updates in terms of pollution. AERMOD was the simulation model adopted to describe the dynamics of gas pollutants dispersed into

air; this is a steady-plume simulation model for emissions generated from surface and elevated sources, it can consider simple and complex terrains and gives the best results for short and middle range simulations (up to 50 km). The results of the study show that the contribution to emissions from shipping activity at the Piraeus Port is 2% for NO_x, 2.5% for Non-Methane Volatile Organic Compound (NMVOC), 0.23% for SO_x and 1.25% for PM₁₀, of the 2018 Greek national reference values for domestic and international navigation, in essence a small overall impact thanks to the use of ultra-low Sulphur fuel. In this study, it is possible to see how emissions are correlated to onboard engines and fuel consumption, and also how it is possible to model this correlation with mathematical equations. Hence, this means that it is possible to reduce emissions by intervening on parameters such as engine and fuel type, nominal power, and so on. Table 2 describes emissions by ship category depending on hoteling and maneuvering operations, Figure 12 shows the annual contribution to emissions generated from cargo handling equipment and road traffic handling, and Figure 13 the amount of emissions in the Piraeus Port in 2018:

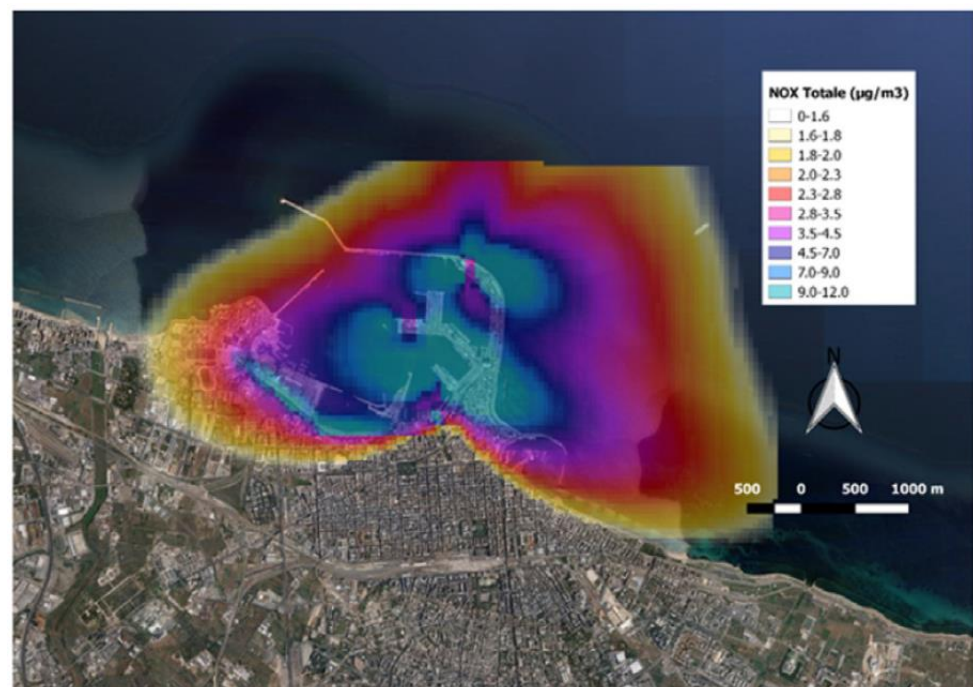

Figure 11. NO_x emissions over the port of Bari. Highest values are colored in blue. Adapted with permission from ref. [45]. Copyright © 2019 Elsevier Ltd. All rights reserved.

Table 2. Shipping emissions for ship categories and hoteling/maneuvering. Reprinted with permission from ref. [46]. Copyright © 2020 Elsevier Ltd. All rights reserved.

Ship Category	Ship Calls	Maneuvering and Hoteling			
		NO _x (t)	NMVOC (t)	PM (t)	SO _x (t)
Passenger ships	13,096	2333	107	101	50.
Cruise ships	512	320	13	12	20
Total	13,608	2653	120	113	70
Container ships	3346	1447	64	63	81
Car carriers	634	237	10	10	39
Ro-Ro	347	29	1	1	2
Total	4372	1713	75	74	121
Grand total	17,935	4366	196	188	191

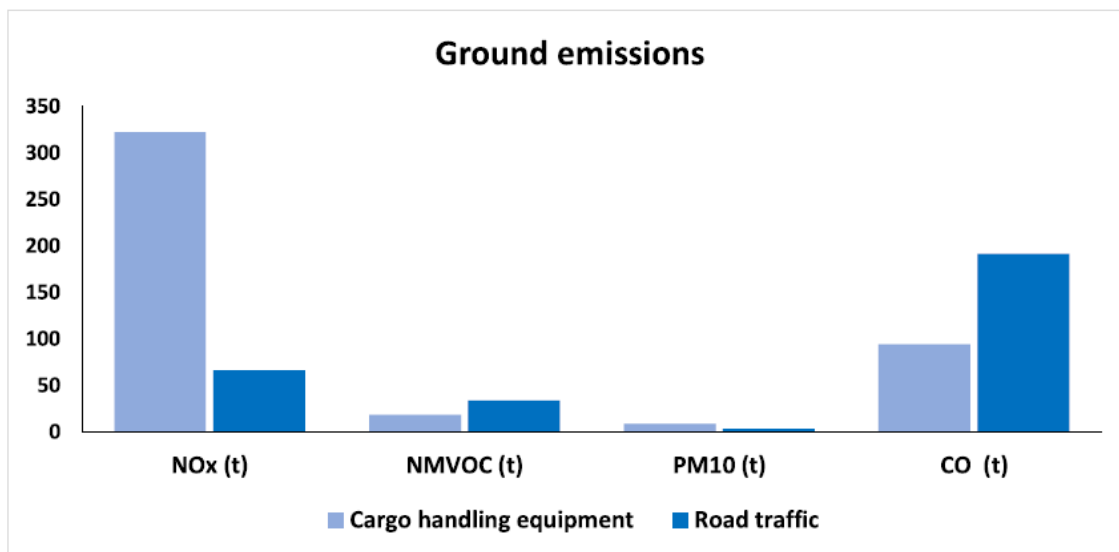

Figure 12. Annual emissions from cargo handling equipment and road traffic. Reprinted with permission from ref. [46]. Copyright © 2020 Elsevier Ltd. All rights reserved.

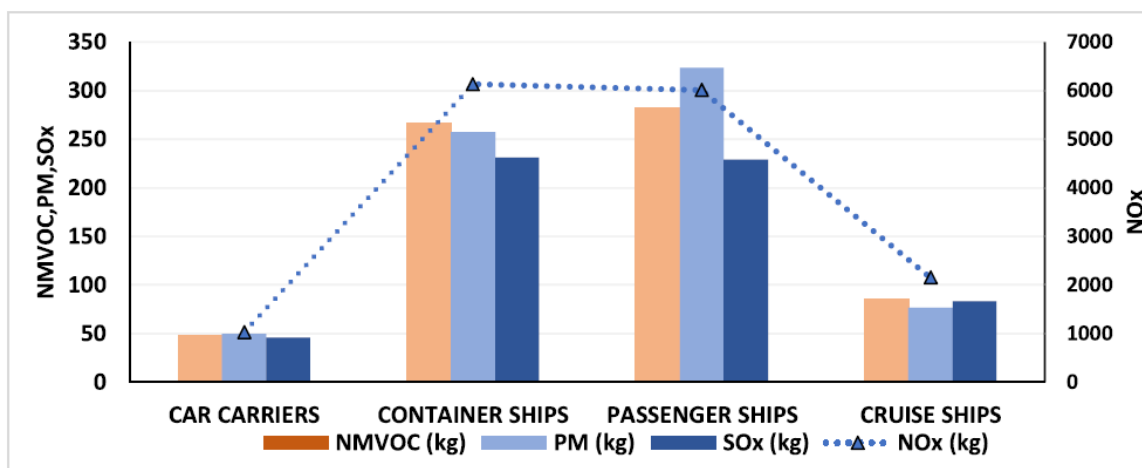

Figure 13. Emissions in Piraeus Port in 2018. Reprinted with permission from ref. [46]. Copyright © 2020 Elsevier Ltd. All rights reserved.

5.5. Port of Valencia, Spain (2019)

Another research study has been conducted for the port of Valencia (Spain) [49] to calculate CO₂ emissions from equipment and machines within the port terminal, through Equation (3) below:

$$CE_x = \sum_{i=1}^4 (a_i * f_f) + \sum_{j=1}^4 (b_j * f_e), \tag{3}$$

where:

- CE_x = Total weight of CO₂ emissions produced at terminal in tonnes;
- a_i = Yearly consumption of fuel in Tonnes of Oil Equivalents (TOEs) with equipment i ;
- f_f = Emission factor in tonnes of CO₂ emission per TOE;
- b_j = Yearly consumption of electricity in kWh with equipment j ;
- f_e = Emission factor in tonnes of CO₂ emission per kWh.

It is interesting to see how this formula also considers electricity consumption and CO₂ emissions per kWh, showing a strong correlation between energy CO₂ emissions. Thanks to this relation, it can be seen how intervening on parameters such as fuel and electricity consumption, through the adoption of sustainable fuels and energy management

systems, can lead to a reduction of emissions. Indeed, this study eventually proposes technical measures to tackle the emissions problem, including replacing traditional fuels such as diesel with more sustainable alternatives such as Liquid Natural Gas (LNG). These topics will be discussed in the following paragraph; the highlight here is that it is possible to estimate emissions in ports through mathematical models, despite all the previously mentioned uncertainties and difficulties. This could be seen as a stimulus to scientific research, so that even more refined and inclusive methodologies are developed in the future.

6. Proposed Actions and Technologies to Manage Emissions in Ports

The following paragraphs will list and describe some of the most effective interventions and technologies that can be adopted to manage the problem of emissions in ports. Mitigation measures mainly translate into reducing the amount of emitted gases, thanks for example to the adoption of alternative power sources, engines and fuels, or by installing on-board exhaust remediation systems; adaptation measures comprehend systems such as carbon capture technologies to collect and exploit the already emitted CO₂ in atmosphere, and scrubbers.

6.1. Power and Propulsion Systems

Thermal engines are heavy emitters of emissions, especially if burning fossil fuels such as diesel. The replacement of thermal engines with electric mitigates the problem of emissions, as the latter do not require the combustion of polluting fuels at all. Electric propulsion systems for ships add up further benefits such as lesser vibrations, reduced dimensions, better energy management, and easier maneuvering operations for ships [50]. The adoption of electrical engines can be thought both for vessels and land vehicles inside the port area; in case of ships, it must consider elements such as available space and geometry necessary for the installation, but also the length of navigation routes because electric motors perform better depending on the type of navigation: electric motors for marine use have greater efficiency for low-range speeds, whereas diesel engines have very high fuel consumptions. It is estimated that powering ships with electrical engines leads to a reduction in fuel consumption by up to 7.66%, a reduction of SO₂ and CO₂ emissions respectively by 16 kg and 5.2 t proportionally to the quantity of consumed fuel, a reduction of NO_x emissions by 26.6%; some minor improvements on cost efficiency also noted, observing a difference in maintenance and operation costs by 1.9% in favor of electric systems [51]. Reduced NO_x emissions can be also achieved thanks to Hybrid propulsion systems [52]: comparing a cruise ship with a 20 MW electrical propulsion power and 5 diesel generators running at 720 rpm to another cruise ship with 20 MW mechanical propulsion plant per shaft and two main 20 MW engines at 500 rpm if four-stroke diesel engines or 80 rpm if two-strokes, the diesel generators in electrical propulsion will produce 9.7 g/kWh, whereas diesel engines in mechanical propulsion will produce 10.5 g/kWh and 14.4 g/kWh if four or two-strokes, respectively (cycle-averaged NO_x production) [53]. With relation to traditional fuels such as diesel and with mechanical components of ship engines, in order to control CO₂ emissions from shipping, in July 2011 the IMO has imposed the mandatory compliance with Energy Efficiency Index Design (EEDI) for ships: this is an indicator that keeps in count those mechanical parameters that can have an influence on CO₂ emissions, thus suggesting areas of intervention to achieve higher efficiency levels. The focus of this paper is however into ports, therefore we will not deepen into mechanical aspects such as hull design, travelling speed, or other parameters involving vessel trips to reduce fuel consumption when travelling; emissions produced by vessels are here relevant when they are found inside the port area. EEDI can be calculated [54] with Equation (4) below:

$$EEDI = \frac{Ep * Fc * CF}{Dt * v} (\text{gCO}_2/\text{ton-mile}), \quad (4)$$

where:

- E_p = Engine power;
- F_c = Specific fuel consumption;
- CF = Carbon factor;
- D_t = Deadweight tonnage;
- v = Speed.

6.2. Alternative Fuels

Emissions produced by ships can be reduced by intervening with technical upgrades in terms of weight and displacement, as well as improving the shape of hulls for more efficient hydrodynamics; engine optimization plays another role, aiming to achieve higher performance, reduced fuel consumption, and energy recovery. The majority of ships are powered by diesel engines, leading to high amounts of CO₂ emissions. Along with the installation of filters, scrubbers, and other similar devices, switching to alternative marine fuels such as Liquefied Natural Gas (LNG) or methanol can help with the reduction of engine emissions thanks to their superior environmental quality [38]. The implementation of alternative fuels could be extended as well to inland vehicles operating inside ports, reducing emissions further.

6.2.1. Liquid Natural Gas (LNG) and Liquid Propane Gas (LPG)

Liquid Natural Gas (LNG) is natural gas in liquid form. It is colorless, odorless, and non-toxic and non-corrosive, and therefore environment friendly and can be employed in sensitive and expensive equipment and machinery. It requires expensive cryogenic systems for liquefaction, therefore its infrastructure and operational costs might be challenging or even out of reach for some companies or countries [54,55]. On the other hand, LNG powered systems offer better performance in terms of sustainability and environmental impact compared to diesel [56,57]. Liquid Propane Gas (LPG), a mix of liquid propane and butane; due to their low density, their carriage requires larger tanks along with detection systems for vapors and leaks. LPG produces no SO_x and reduced PM_x but higher amounts of CO₂. LPG gets liquefied through light pressures. Figure 14 [58] below shows the cumulative amount of LNG ships already built or being ordered before mid-2018, with the exclusion of LNG carriers. Figure 15 [58] displays the life-cycle GHG emissions for cruise ship engines and by fuel type for a 100-year Global Warming Potential (GWP). Being LNG composed of methane for the most part, the “methane slip” surplus consists in the unburned methane fraction escaping into the atmosphere during the combustion process.

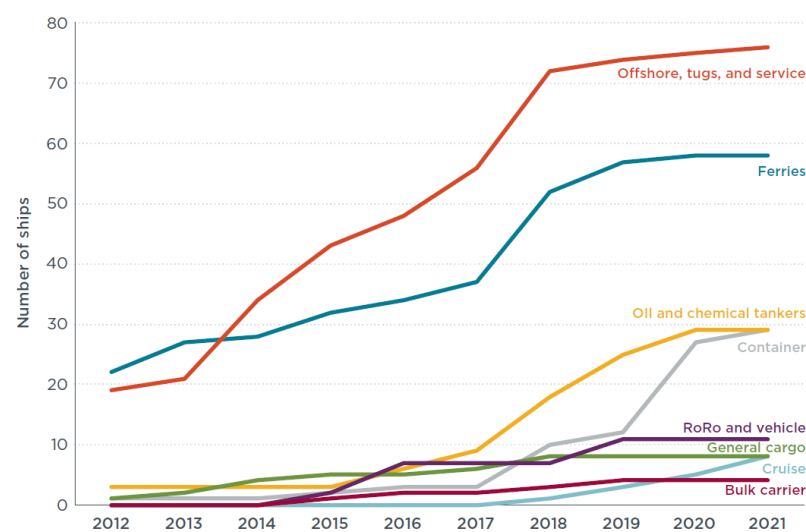

Figure 14. Number of ships build or ordered by mid-2018. Reprinted from ref. [58].

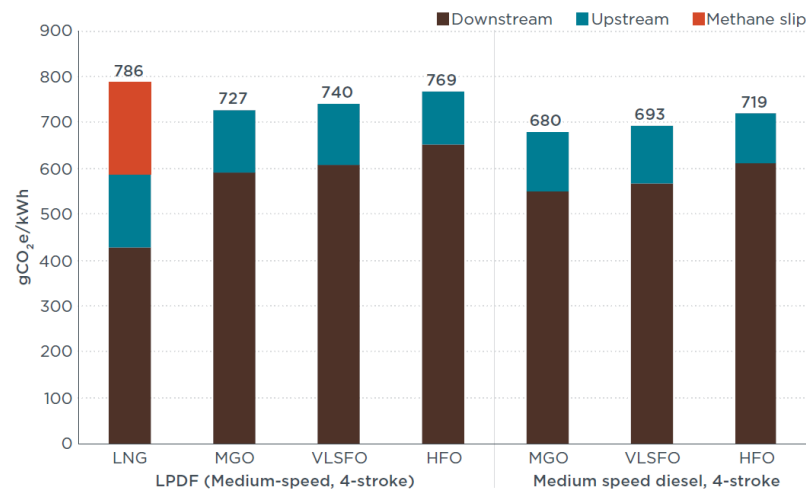

Figure 15. GHG emissions for cruise ship engines, 100-year GWP. Reprinted from ref. [58].

6.2.2. Biofuels

Biofuels are generally derived from biomass and are considered a renewable energy due to their lower levels of pollutant emissions and sustainable source regeneration. The adoption of Biofuels in the maritime sector, replacing traditional fuels [59], could make a significant contribution to the containment of greenhouse gas emissions, also reducing the consequences on people’s health. It has been estimated that the exposure to shipping emissions caused by fuel combustion is responsible for 432 premature deaths per year across the Mediterranean coastal cities, i.e., 5.5 premature deaths every 100.000 inhabitants per year [60]; even if this impact is lower if compared with the typical urban sources, its seriousness is still significantly worrying. It is clear that should Biofuels become mainstream, many ports will have to upgrade their infrastructure in order to be able to store these types of fuels, making necessary the construction of adequate fuel tanks and fuel transfer systems. Bio oils are obtained through advanced chemical processes such as pyrolysis, hydrothermal liquefaction, and solvolysis; these oils come out in different qualities, with properties that vary depending on production process, source of feedstock and recovery techniques, implying a difficulty of presenting a generalized description. These types of oils tend to deteriorate quickly when stored at high temperatures or when exposed to oxygen. Sustainability might be challenged by feedstock availability, and costs can be high if compared with traditional fuels; processes such as pyrolysis are relatively cheap, however the obtained oils must be further refined and upgraded with expensive technologies for its use in transportation. In the end, the GHG emissions from their combustion are lower than traditional marine fuels from 90% down to 50% [61]. Some among the principal biofuels for maritime use are briefly listed below:

- Straight Vegetable Oil, potentially unsustainable because it is almost totally derived from agricultural crops, as well as being impractical as it compromises the engine lifespan due to its high viscosity and boiling point [62–64].
- Hydro-treated Vegetable Oil, obtained from converting vegetable oils or animal fat through Catalytic Hydro-Deoxygenation (HDO) and with similar characteristics to fossil diesel, but with sustainability issues related to its availability and procurement operations (palm oil, animal fat) [65,66].
- Fischer-Tropsch diesel, processed from coal and natural gas (more consolidated technology) or from Biomass to Liquid (more experimental processes), presents a high quality but high costs (mainly capital) involved in its production, associated with low production efficiency [67,68].
- Bio-Ethanol, the most widespread biofuel in the world, but not for seaborne transport. Almost exclusively produced from fermentation of starches and other food crop sugars, although new alternative extraction processes are in development. When not aided by other GHG reduction technologies, the achieved performance is however lower than

for other biofuels such as Bio-Methanol. Its use for maritime transport is currently minimal, with few or no related projects at the moment [69,70].

- Bio-Methanol, produced from biomass instead of fossil fuels such as standard Methanol. The procurement of biomass can be challenging due to availability and logistic difficulties, eventually becoming an uneconomical process, in addition to production costs. Besides, biomass can also add a further impact upon GHG emissions on its own (for example from feedstock); Bio-Methanol has already been tested and used as a diesel fuel for marine engines, which appear to require technical adjustments to cope with its corrosive nature and high auto-ignition temperature. The levels of GHG emissions from Bio-Methanol are anyways lower when compared with common Heavy Fuel Oil (HFO) and Marine Gas Oil (MGO) [71,72].
- Bio-Dimethyl Ether, which can be a direct substitute of diesel fuels. It can be produced from processing Methanol with expensive production processes. It is hence derived from fossil fuels, and its production processes hold similar pros and cons of those for Methanol. Having a similar behavior to Propane, the same storage and distribution infrastructure can be used on ships and ports; it is more compatible than Methanol with diesel engines, requiring minor adjustments, although presenting low viscosity and lubricity that does not facilitate engine movements. It is characterized by a clean combustion and consequently by clean emissions [73,74].
- Bio-Liquid Natural Gas (Bio-LNG), and Liquefied Bio-Methane (LBM), obtained from several complex production processes, have the disadvantage of a limited supply, having to rely on feedstock availability and transportation, considering that feedstock is also used for other competing industries, as well as its derivate fuels. LNG can lead to a phenomenon called “methane slip”, meaning that part of the methane, which is a potentially hazardous GHG gas, can leak into the atmosphere during transfer operations or even during combustion. Bio-LNG is however a very attractive fuel for maritime transportation due to its clean emissions, considering for example the much lower SO_x emissions compared to low-Sulphur distillate marine fuel [75–78].

6.2.3. Other Green Fuels

- Ammonia (NH₃), commonly used as a fertilizer, can also be used as a fuel both by direct combustion and stored in fuel cells [79,80]. It is produced almost totally starting from fossil fuels (natural gas) and a sustainable ecological production would require significant renewable resources. GHG Emissions from marine engines using geothermal-based ammonia as dual fuel can decrease up to 33.5% tonne/Km, and up to 69% if used as a unique type of fuel [81].
- Hydrogen (H₂), for electric engines. Can be produced either from fossil fuels but also from water electrolysis with green electricity, in this case meaning theoretically zero-emission ships. The required raw materials are only oxygen and nitrogen, and the byproducts are just heat and water. Hydrogen as a fuel needs large storage tanks both in liquid and gas forms, besides dedicated bunkering infrastructure currently not available [82,83].

6.3. CO₂ and Carbon Capture Systems

Besides switching to green fuels and pursuing energy efficiency, Carbon Capture Systems (CCS) are another solution to reduce CO₂ emissions. This technology can be installed directly on-board, and there are three main types of CCS: pre-combustion and oxy-combustion systems, which would require invasive modifications on the engines, and post-combustion systems that do not require any engine adjustment but still require the installation of gas treatment hardware [84]. Once captured, CO₂ must be stocked on-board; in its gaseous form, CO₂ would occupy a large storage volume which is not available on vessels as space must be reserved for goods and facilities, therefore CO₂ must be liquefied and stored inside tanks: this operation requires the installation of compression and liquefaction systems. Besides, CO₂ carrier tankers can directly inject and store liquid

CO₂ inside their own tanks [85]. CO₂ can also be stored on-shore, still requiring large spaces. The percentage of re-captured CO₂ varies significantly depending on many technical parameters, such as fuel and engine type, CO₂ capturing solvents and storage conditions; in any case, these systems absolutely prevent a certain percentage of CO₂ from exhaust gases from entering the atmosphere and harming the environment [86]. For the mechanical and process engineering enthusiasts, Figure 16 shows an example of process schematics for an on-board post-combustion CCS connected to a LNG-powered engine.

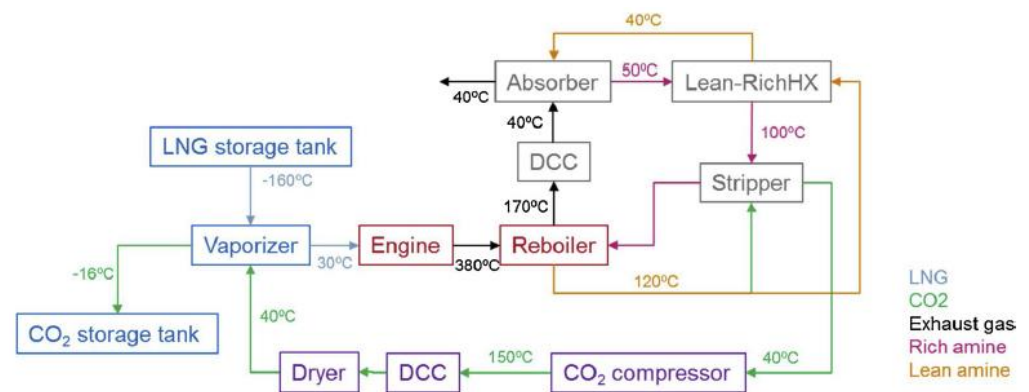

Figure 16. Process schematics for an on-board post-combustion CCS integrated with a LNG-powered engine. Reprinted with permission from ref. [86]. Copyright © 2019 Elsevier Ltd. All rights reserved.

6.4. SO₂ and Scrubbers

Scrubbers are devices designed to reduce particulate matter or gases from industrial exhausts, and they can also be employed onboard in ships to reduce PM_x and SO_x emissions; wet scrubbers come in three different types: open-loop systems using seawater to scrub exhaust gas removing SO₂, closed-loop systems using fresh water treated with sodium hydroxide, and hybrid systems that can be operated in both modes. In dry scrubbers, water is replaced with slaked lime Ca(OH)₂ [84]. Research studies have shown that their operation can bring an abatement of PM_x emissions up to 75%, strongly depending on number, type, and load of engines and adopted fuel [87]. Scrubbers can significantly reduce SO_x emissions, with an abatement of SO₂ emissions by 31% lower than 0.07% sulfur MGO [88]. Figure 17 depicts an example of the process schematics for an open-loop scrubbing system [89].

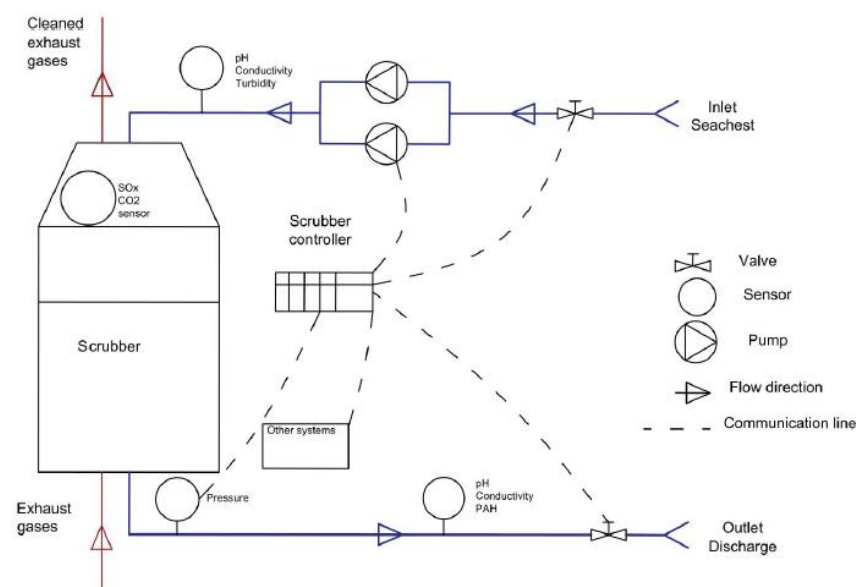

Figure 17. Schematic drawing for an open-loop scrubbing system process. Reprinted from ref. [89].

6.5. Renewable Energies: Photovoltaic, Wind, and Fuel Cells

Renewable energies are today part of a global energy transition scheme, aiming to reduce the dependence on fossil fuels and using alternative green sources such as solar and wind energy, biogas, and even tidal and wave energy. Since ports are connected to the inland electrical network in order to provide electricity to machinery but also lighting, air conditioning systems and so on, they do have an impact on electricity consumption and thus on the deployment of fossil fuels and related polluting emissions from combustion. Switching to sustainable green sources would lead to a general energetic relief, but in this sense, ports could also be seen as standalone infrastructures with their own smart-grids locally producing electricity from renewable sources. This can be imagined by planning to install photovoltaic panels on roofs, or wind turbine generators (perhaps off-shore if financially convenient and not interfering with ship operations), biogas, or even from fishing harbor waste or exploiting tidal and wave energy with the latest technology. Even if not fully energetically autonomous, ports could benefit from these forms of energy production of up to 60% of their daily requirements [90]. Photovoltaic and wind energy applied to maritime transport impact in terms of emissions by reducing CO₂ up to 32% and 12% from photovoltaic and wind, respectively [54]. The role of wind has always been important within the maritime industry, as it was one of the most important forms of propulsion in the past, characterizing entire historical eras. Since this study wants to focus on ports, the role of wind energy will be treated for inland infrastructure, leaving on purpose to other research works the ship-related aspects. A research study conducted in Iran has examined the possibility of using wind energy to produce hydrogen from sea water, choosing various coastal cities on both coasts (Southern and Northern) for their case study. The wind energy generation potential was evaluated with a statistical approach (Weibull distribution), calculating how much energy could be generated by commercially available wind turbines and the quantity of desalinated water and hydrogen could be produced with this energy. Among the assessed locations, the port at city of Anzali on the Northern coast was the location with the highest efficiency for producing electricity from wind: a single EWT direct wind 52/900 turbine installed inside the port can generate annual energy for 2315.53 MWh, meaning a net annual reduction of CO₂ emissions of 1804 tons, and 439,950.7 m³ of treated water or 35,973.49 Kg of hydrogen produced in one year. In the end, a wind farm with 55 turbines would be sufficient to produce enough hydrogen to fuel all the cars in the same city of Anzali [91]. In this sense, this energy could be used by the port itself, perhaps making it energetically autonomous or less dependent on the national network. Another study, carried out for the port of Alexandria, Egypt, shows that the implementation of Offshore Wind Turbines and Fuel Cell technologies for port energy demands means an expected emission reduction of 80.441 ton/yr for CO₂, 20.814 Kg/yr for CO and 133.025 Kg/yr compared to the national electric grid [92]. Another study for the port of Damietta, Egypt, showed that a combined use of Fuel Cells (providing 67.9% of the power system) and Offshore Wind Turbines (10 OWT units providing the rest) would reduce CO₂ emissions by 32.176 tons/yr, NO_x by 8.32 tons/yr and CO by 53.2 tons/yr [93]. The selection of the best fitting renewable energy for a port can be assessed with the FITradeoff method, a multi-criteria decision model examined in a research study for Brazilian ports. The study considers three forms of renewable energy: photovoltaic, wind, and wave energy, and defines 20 criteria introduced after a brainstorming process that keeps in count sustainability aspects, national standards, available literature, and so on. Wind energy was opted out for not resulting in a potentially optimal alternative, i.e., its mathematical value within the model had much lower weight compared to the others. The study finally revealed that photovoltaic energy seems to be the most viable type for Brazilian ports [94]. Figure 18 below shows a radar chart with the 20 criteria; blue line stands for photovoltaic energy, whereas orange is for wave energy. Area subtended by the blue line is larger than orange, comprehending higher values of the 20 criteria and therefore meaning that photovoltaic is more viable than wave energy; wind energy is not represented, being it opted out in the process.

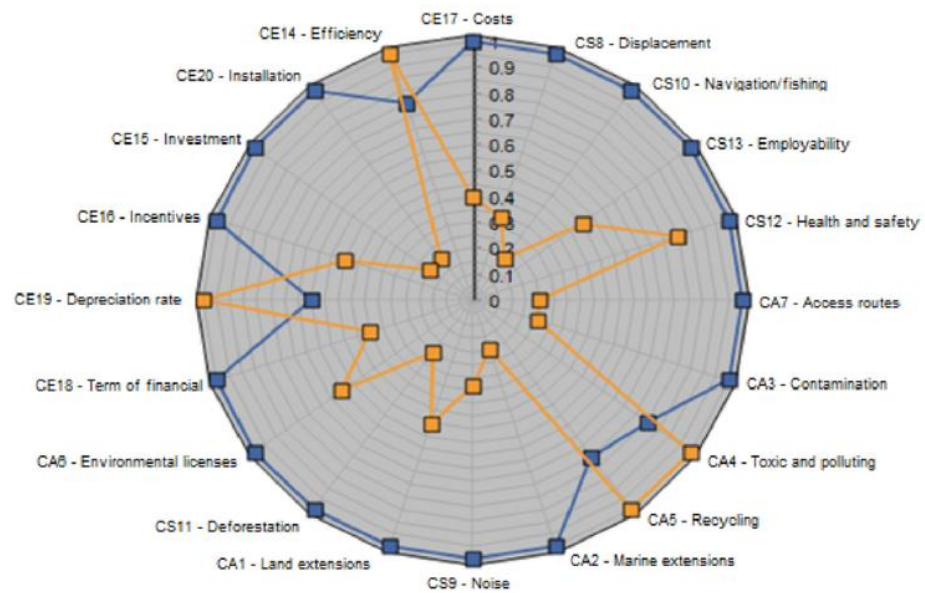

Figure 18. A radar chart with the 20 criteria, showing the predominance of photovoltaic over wave energy. Reprinted with permission from ref. [94]. Copyright © 2020 Elsevier Ltd. All rights reserved.

Speaking of the administrative side of the subject, renewable energies will require attention by a multitude of diverse stakeholders, from governments and agencies to citizens and port users. An example of multiple stakeholder involvement was investigated for the port of Rotterdam, describing how citizens and companies can invest in renewable energies through Renewable Energy Cooperatives (REC) even for ports, examining the port of Rotterdam as a particular case [95]. The flowchart in Figure 19 shows an example of an action plan for launching a REC.

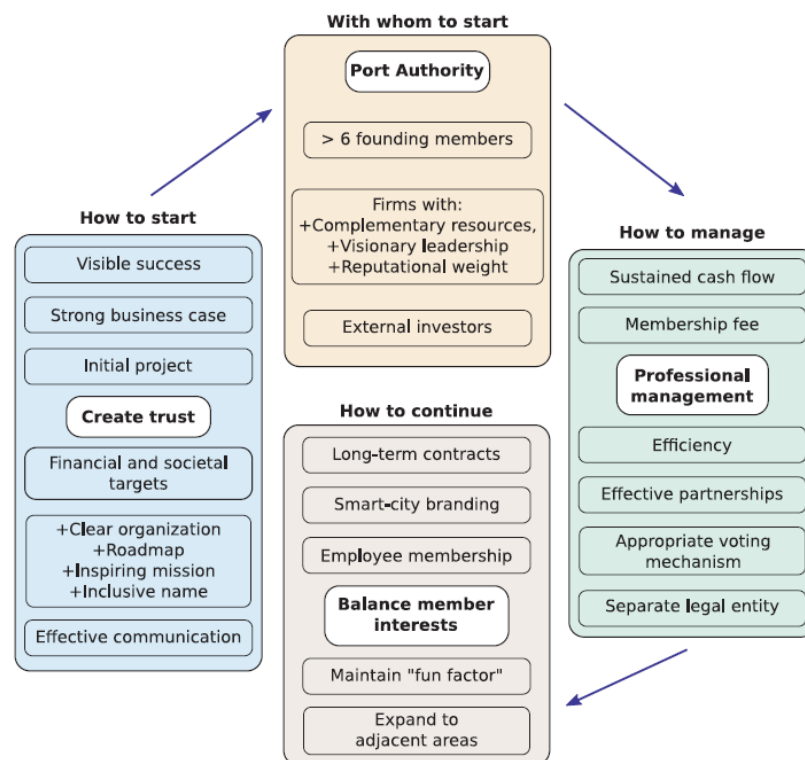

Figure 19. Action plan for launching a REC. Reprinted with permission from ref. [95]. Copyright © 2018 Elsevier Ltd. All rights reserved.

6.6. On-Board Energy Management Systems

During their stay within the port area, ships must often keep their engines on, especially in order to guarantee the functioning of onboard machinery, lights, air conditioning systems, and so on; this inevitably means an additional contribution to polluting emissions in ports, as maritime engines are heavy emitters. Through the application of mathematical and statistical models to seaborne technology, it is possible to optimize onboard energetic processes on vessels by reducing for example fuel consumption and thus reducing pollutant emissions [96]. This can be achieved thanks to the application of statistical models [97] and devices that intervene on the technical operations of onboard motors, setting for example the optimum amount of injected fuel or the best start injection angle, or acting on the ship electric distribution architecture, with calculations exploiting mathematical approaches such as fuzzy logic [98,99]; these statistical models allow the analysis and comparison of results thanks to the calculation of specific indexes that describe energy efficiency, fuel consumption or produced emissions. Other forms of energy management may consider the impact of those elements related to navigational operations (for example, weather conditions). Besides reducing emissions, another benefit deriving from the application of energy management measures consists in a reduction of costs, since less fuel is consumed [100]. A first action can be directed towards a rational and efficient selection of the required onboard engines: choosing the proper motors can lead up to 2.4% of energy savings; the application of Waste Heat Recovery systems exploiting a steam-based Rankine cycle in cogeneration mode, a Rankine cycle optimized for maximum power out and an organic Rankine cycle using ethanol leads to energy saving ratios of 3.5%, 4.8%, and 6.9%, respectively. The use of batteries can help with achieving a more uniform engine distribution, flatten large load fluctuations and reducing peaks, so that engines can operate closer and longer at their highest efficiency point: this can allow energy savings for up to 1.8% [101]. Thanks to installed WHR systems, it is possible to reduce fuel consumption saving at least EUR 155 K per year and EUR 3.1 M over 20 years, with systems using benzene allowing even larger savings for EUR 186 K per year and significantly reducing CO₂ emissions over one year of operations [102]. Figures 20 and 21 respectively show Fuel Savings per Year and Annual CO₂ Emission Reductions for different working fluids employed in WHR systems on Aframax ships (Average Freight Rate Assessment Max vessels, i.e., oil tankers with a deadweight between 80 K and 120 K metric tonnes), with savings ranging between 150 K EUR/yr (water) and 186 K EUR/yr. (benzene), and CO₂ Emission Reductions ranging between 705 tonnes/yr (water) and 849 tonnes/yr (benzene).

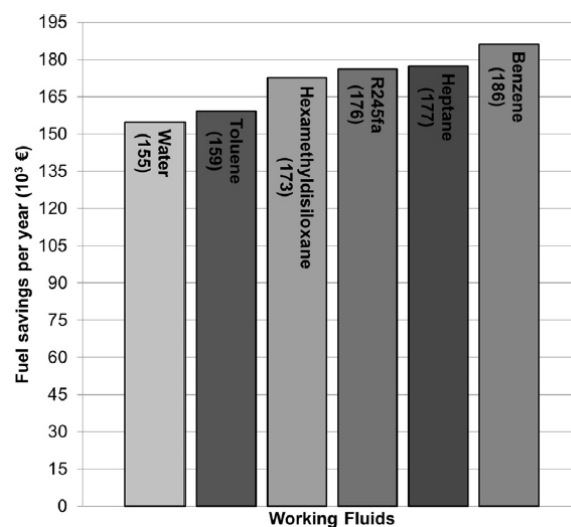

Figure 20. Fuel savings per year for different WHR working fuels. Reprinted with permission from ref. [102]. Copyright © 2016 Elsevier Ltd. All rights reserved.

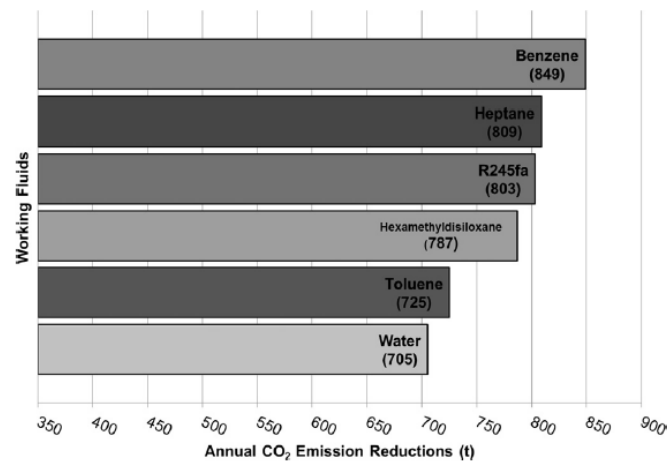

Figure 21. Annual CO₂ Emission Reductions for different WHR working fuels. Reprinted with permission from ref. [102]. Copyright © 2016 Elsevier Ltd. All rights reserved.

6.7. Smart Grids, Energy Management, and Cold Ironing

Renewable energy plants can be seen as part of larger projects including Smart Grids, therefore as an element within a specific electric network comprehending vehicle recharging stations, lighting and air conditioning systems, electric machinery such as port cranes and so on, all of which can be managed and optimized by Artificial Intelligence via sophisticated computer algorithms improving efficiency [103,104]; port electrification and Shore-Side Power (SSP) connections, with systems such as Cold Ironing, are further related technologies that will be described in this paragraph. Smart Grids allow a better management of the electricity network, optimizing for example the demand peaks and fluctuations across time. Several devices and machinery are operated for port activities, for example cranes are needed to move goods and containers across the port and to load/unload ships. The loading/unloading operations are typically affected by two factors: the ship stability and the number of unproductive moves. The simultaneous operation of cranes leads to a higher demand of energy, therefore increasing the peak demand and energy related costs. Peak shaving consists in levelling out peak use of electricity by lowering the highest peak of energy demand, reducing the related energy costs; peak shaving consists in removing the peaks, whereas load levelling is indeed about levelling and flattening the energy load curve. It has been estimated that peak demand and the related costs can be reduced by 50%, also reducing container operation and handling times, by either reducing the maximum energy demand of all operating cranes, or by limiting the number of cranes operating at the same moment; it has also been demonstrated that the implementation of such measures translates into saving EUR 250 K/yr, i.e., around 48% of peak-related total energy costs [105]. The amount of current scientific literature about specific port-related smart grids appears to be quite exiguous, and the authors of this article believe that this subject might constitute a challenging and vibrant opportunity for present and future research, considering also how fast the IT and electronic industries are evolving day by day. Smart grids are very useful especially if integrated with technologies such as Cold Ironing. Cold Ironing, also known as Onshore Power Supply, Alternative Maritime Power (AMP), Shore-to-ship Power Supply, or Shore-side Electricity, consists in the supply of electricity from the port to berthed ships, allowing them to switch their on-board main and auxiliary diesel engines off while moored: in this way, a vessel will not have to rely on on-board power supply, exploiting electricity provided from the onshore electricity grid instead [106,107]. Figure 22 shows the schematics of SSP connection between ship-side and port-side for a smart grid infrastructure, and Figure 23 displays the connection of in-land electricity grids to moored ships through Cold-Iron systems.

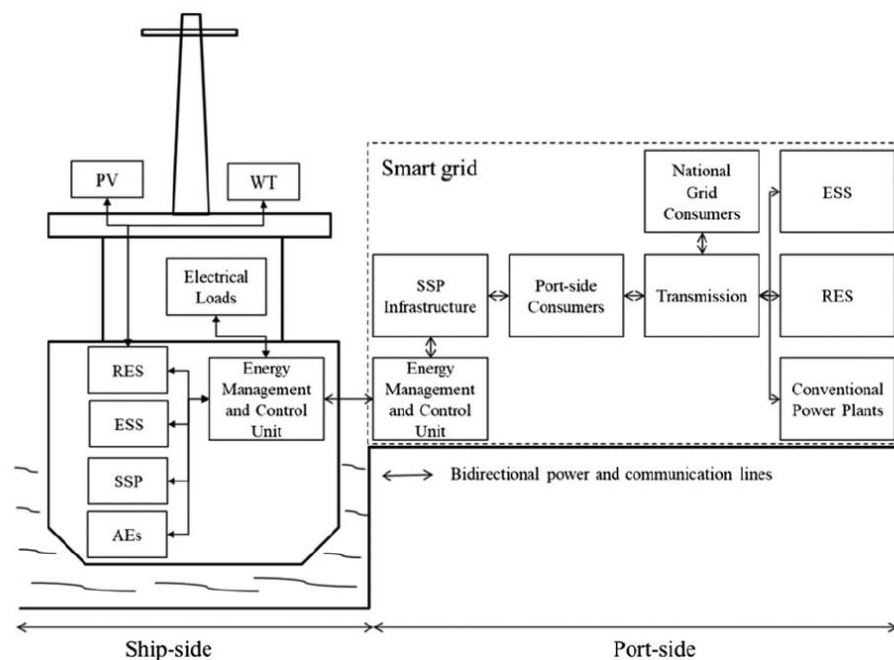

Figure 22. SSP connections with smart-grid. Reprinted with permission from ref. [103]. Copyright © 2018 John Wiley & Sons, Ltd.

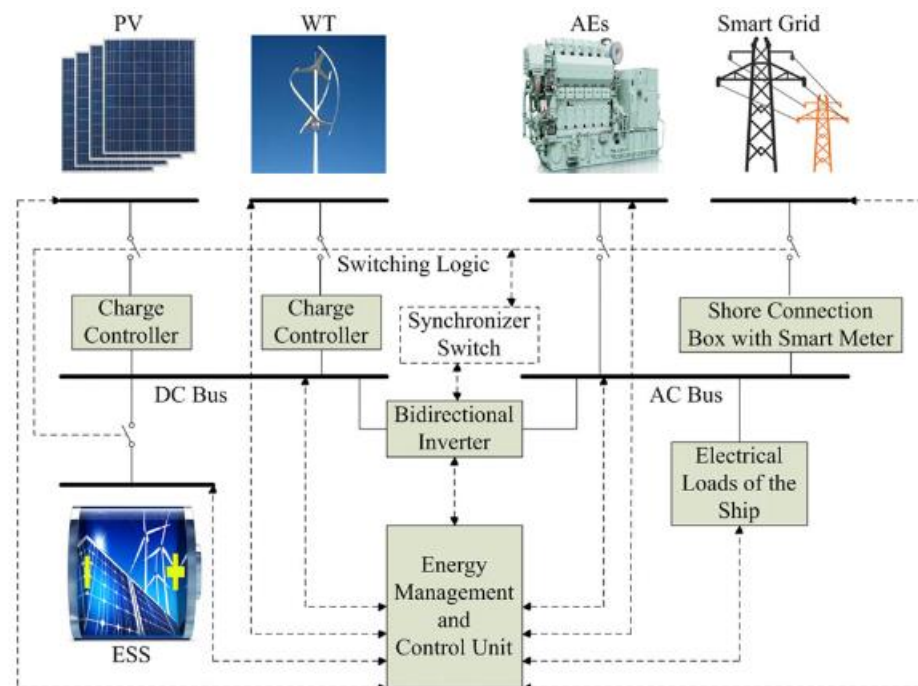

Figure 23. Control and power switching topology for the ship and smart grid system. Reprinted with permission from ref. [103]. Copyright © 2018 John Wiley & Sons, Ltd.

With this technology, ships will not need to keep their engines and generators turned on whilst docked at berth and not traveling, thus reducing fuel consumption and therefore emissions; this aspect can assume significant proportions, speaking for example about cruise ships which can basically be considered as seaborne small towns on vessels [108]. It has been estimated that the daily emissions from cruise ships alone are equivalent to one million cars, that air quality on board of cruise ships can be compared to world’s most polluted cities, and that through an efficient, coordinated, and synchronized use of Cold Ironing 800,000 tons of CO₂ emissions could be mitigated annually [109]. It can

be stated that Cold Ironing can achieve an abatement of local emissions by between 48% and 70% for CO₂, between up to 60% for SO_x, and between 40% and 60% for NO_x of a container terminal ship emissions inventory [110]. Integrated systems of Cold Ironing and Cogeneration Power Plants can lead to the prevention of 110 tonnes of NO_x, over 2 tonnes of PM₁₀ and over 4 tonnes of SO_x per year; the best setups can even abate emissions by 98.58% for NO_x, 79.06% for PM₁₀, and 100% for SO_x [111]. Hoteling ships require indeed a certain amount of energy to power up on-board temperature control systems (heating, cooling, etc.), emergency equipment, lights, pumps, and other machinery; in order to estimate emissions, fuel consumption at berth for each engine $i \in \{a, b\}$ can be calculated [112] through Equation (5) below:

$$FC_{B,k}(ton) = \sum_{i \in (a,b)} 10^{-6} * 9(SFOC_{i,b,K} * EL_{i,b,K} * EP_{i,K}) * t_{B,k} \quad (5)$$

where:

- SFOC = Specific Fuel Oil Consumption (g/kWh);
- EL = fractional load (%) of the nominal power EP;
- EP = Nominal Power (kW) of the auxiliary engines (a) and boilers (b);
- $t_{B,k}$ = Duration of the ship at berth.

Cold Ironing systems are composed of three parts: the onshore power supply system, a connecting system between shore and ship, and an on-board power receiving system [113], and it must be necessary that ships and ports share the same electricity technical standards with homogeneous characteristics, to avoid compatibility problems: this requires particular attention for international ports, as international standards for electricity may vary significantly. A research study has been carried out for the Port of Mytilene, in Greece; the port infrastructure is located in proximity of urban settlements, along the city limits, and constitute a source of pollution especially during the tourist seasons. The first step of the adopted approach was the assessment of ship emissions in port during berthing and maneuvering operations, estimating that between the 10th and 20th August 2012 (tourist season period) 441 Kg of PM₁₀ and 282 metric tonnes of CO₂ were emitted, of which 63% of PM₁₀ and 77% of CO₂ emitted whilst berthing and the remaining at maneuvering. Renewable energy sources (wind and photovoltaic) were then simulated with a micro-grid energy simulation software, discovering that the combination of four 1.5 MW wind turbines and a 5 MW photovoltaic plant would actually fully satisfy, if not exceed, the energy demand of the ships in port. As the supply of electricity comes out to be in excess, the surplus could be distributed to the island grid, thus making unnecessary to install batteries in the port to prevent power shortages, meaning avoiding the battery related costs. This system also has a positive impact on the environment, thanks to reduced PM₁₀ and CO₂ emissions as the ships can switch onboard engines off and instead use on-shore electricity, and considering also that the adoption of renewable energies, sustainable and with zero emissions, remove the pollution caused by traditional power plants burning fossil fuels [114]. Figure 24 shows the layout of a typical Cold Ironing on-shore substation, where electricity can only flow from the shore supply towards the ship; new research technology is evaluating the possibility of a bi-directional electricity flow [115].

A research study has been performed to assess ship emissions relative to Cold Ironing for the port of Iskenderun, in Turkey, carrying out data analysis for ship emissions at berth in 2013; researchers have also made a comparison of environmental performance when using shore-side electricity, and eventually also examined the externalities linked to emissions finding, which, thanks to Cold Ironing, makes it possible to save circa \$23 M (USD) of external costs per year [116]. Ship emissions have been estimated with two methodologies, the first consisting in a top-down approach using marine bunker statistics, and the latter being a recommended ship movement methodology when detailed technical data and movement information of ships is available. Emissions were calculated for each ship individually as a sum of emission contributions from hoteling, maneuvering, and cruising of the ship; furthermore, the calculation considered specific parameters such as

number of ship arrivals at the port, time spent at the port, average fuel consumption from auxiliary machinery and pollutant emission factors of the auxiliary engines. Finally, once emissions have been found and given the unit costs per ton of pollutant emission, total emission costs were calculated and compared with the total cost due to fuel consumption of auxiliary machinery, showing emission external costs to be higher. Eventually, the amount of electricity required to power the same auxiliary machinery was calculated along with its related cost, showing that switching to renewable energy sources would allow saving \$23 M per year in terms of emission external costs. The study concludes by drafting some technical specifications for the necessary upgrade works to make a port ready for Cold Ironing; the cost evaluation for these infrastructural upgrades is not shown, however it is suggested that port authorities could rely on credits and subsidies, as this technology (especially electricity transformation) can be relatively expensive. Cold Ironing technology is relatively recent and it is becoming more globally widespread with time, with existing Cold Ironing systems already in place or planned in Europe, North America, Asia, and Oceania. The spread of this technology faces various obstacles, some being of technical nature having to install specific apparatus in ports, availability and quality of inland electricity, type of frequency, and risk of network overloads. The financial aspect can also constitute a relevant issue, as the implementation of these systems, along with the necessary port and ship updates and constant maintenance, naturally implies costs which cannot always be sustained by port Authorities and ship-owners even considering long-term investments [112]. Subsidies and credit systems might help with the spread of shore-side power supply, likewise stakeholders could be pushed towards this technology with more severe regulations and higher charges for emissions [117]. This technology is also relatively recent, and therefore there is not much available experience in terms of dedicated policies and guidelines. A study recently carried out in China [118] has developed a complex fuzzy DEMATEL (Decision Making Trial and Evaluation Laboratory) model to spot the most critical restrictions that can arise when promoting and implementing AMP (Cold Ironing) in China. Results from the study identify three significantly impacting constraints, being in order of importance: Policies and supporting systems (named “factor F10”), AMP construction standards (“F11”), and finally Systems for laws rules and regulations (“F12”). Factor F10 appeared to be the most important factor, affecting the others; F12 and F11 were in order of importance the two most influencing factors for the application of AMP in China. The flowchart in Figure 25 explains the procedure and steps followed for the mentioned study.

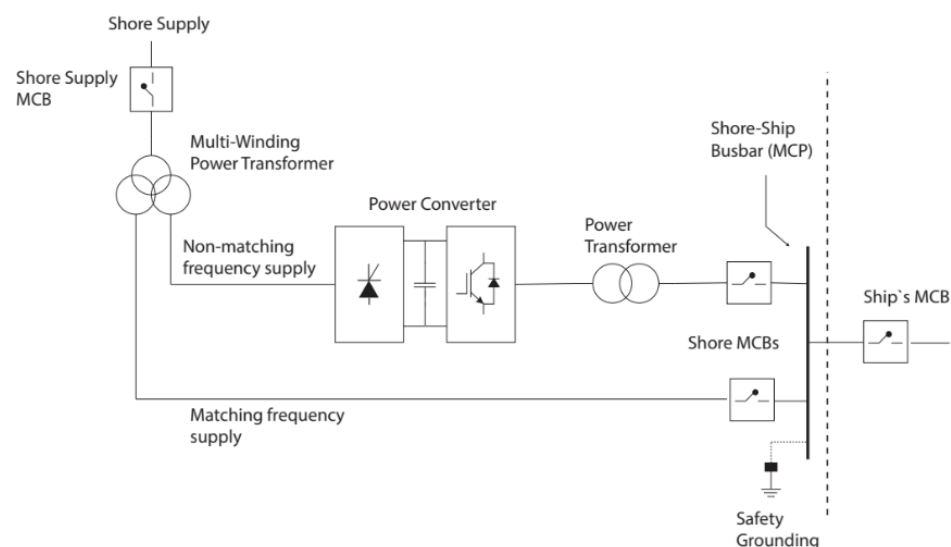

Figure 24. Layout of a typical Cold Ironing on-shore substation. Reprinted from ref. [115].

As already seen before, when moving inside port waters ships have to perform specific maneuvers, often requiring frequent changes in engine power. Ship emissions in ports are therefore also affected by the type of maneuvers (which might request more or less time and therefore more or less fuel and emissions), by engine use and fuel consumption, and also by the efficiency of tug assistance: ships in ports sometimes require the assistance of tugboats pulling them around to facilitate maneuvers, and these too give their contribution to pollutant emissions. These performances are also influenced by human factors, because ship maneuvers are conducted by ship’s crew and port pilots [119]. The introduction of Autonomous Vessels [120] could lead to multiple benefits as it can optimize maneuvering times, allowing furthermore to eliminate all the onboard facilities built for the crew, and leading to a reduction in ship weights, wind loads, consumed energy, and GHG emissions [121]. Ports of course will require technological upgrades, mainly for communication systems [122]. Figure 26 below schematizes an example of a communication system between an autonomous ship and other maritime entities, including the port infrastructure.

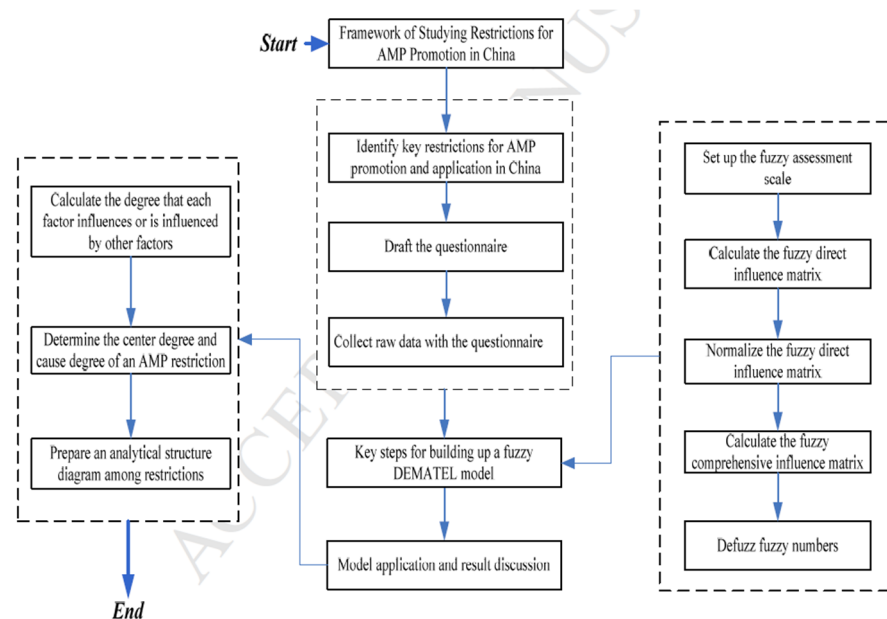

Figure 25. Flowchart of a Cold Ironing implementation process. Reprinted with permission from ref. [118]. Copyright © 2018 Elsevier Ltd. All rights reserved.

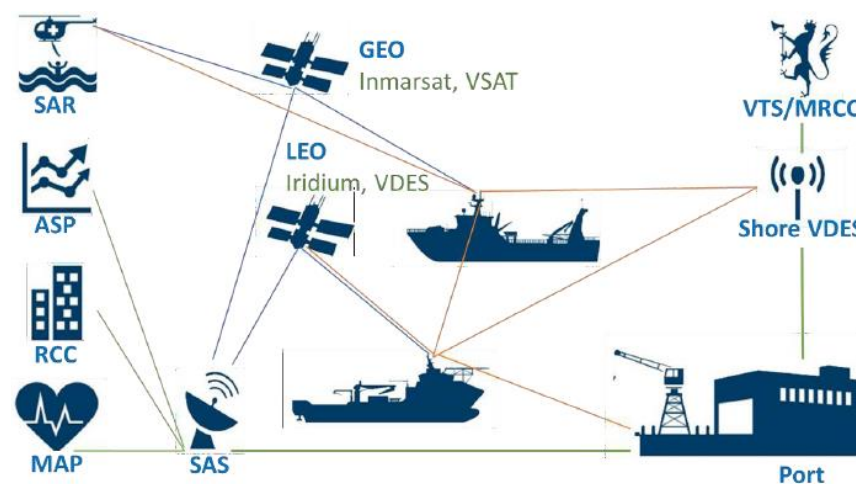

Figure 26. Communication system between autonomous ships and other maritime entities, including the port infrastructure. Reprinted from ref. [122].

7. Discussion

Maritime transport and ports have characterized the history of mankind since ancient times, certainly for at least a few thousand years now. However, it is in the last decades, specifically in the last century and in particular from its second half, that its environmental impact has reached worrying levels for climate and sustainability and the related risks. This is occurring mainly due to a rapid and massive increase in the world population, which is corresponding to an equally significant increase in the demand for the transport of goods and people; another correlated reason is to be found in the use of highly polluting fossil fuels, both for inland port activities and for the propulsion of ships. Speaking of ports, it has been seen in this paper how emissions are related to many different features such as port geographical location, ship engines, inland machinery and activities, fuel types and energy consumption, road traffic related to the port, and so on. All these parameters can be translated into mathematical models and then into computer algorithms, making it possible to predict the impact on emissions after intervening on such parameters. As seen in the previous chapters, a properly modelled port layout, along with fitting algorithms, can help Authorities and private companies on deciding which technical solution to implement in order to forecast and reduce emissions, thus improving their environmental impact, their reputation and also reducing the related costs (e.g., fuels and electricity). Some research studies are already showing how the transition to green fuels lead to environmental benefits in terms of reducing emissions: for example, it has been seen that the 99% of ship voyages along a PRD-SPB corridor (a route between the Pearl River Delta in Guangdong, China, and the San Pedro Bay in California, USA) can be successfully performed by using hydrogen in place of traditional fossil fuels [123]. In detail, this is achieved by dedicating a further 5% of a ship's cargo space to expand the onboard hydrogen storage volume, or by providing an additional stop in a port along the journey to refuel; moreover, it has been seen that 43% of journeys are achievable even without having to expand the ships fuel capacity, nor having to refuel along the voyage. The Netherlands have a strong port activity, with 17 active ports, of which 2 are among the most important in Europe for millions of traded tons: the first is the port of Rotterdam, while Amsterdam is the second in the Netherlands and fourth in Europe. The importance of these two ports is also derived by their Oil and Gas activities, including the transport and processing of these type of resources [124], with the related environmental consequences. Hence, these ports are already putting efforts into transitioning to alternative low-carbon strategies, with the port of Rotterdam for example aiming to reduce the CO₂ emissions within the port and city areas by 50% before 2025, against 1990 levels, thanks to a 2007 joint initiative called RCI between the port Authority and the municipality [125]. Ideas for future research can hence develop towards the replacement of traditional fossil fuels with renewables and green energies over time, studying the effects on environment and the financial benefits as well. Other topics could be the implementation of the latest technology such as drones to survey and monitor emissions, or autonomous vessels to optimize port maneuvers by connecting them to an inland port electronic system by a shared communication network. Other research fields might focus on CO₂ capture, storage, and reutilization, assessing the impact on port and onboard infrastructure (e.g., reservoirs) and considering also the commercial side (for example, supercritical CO₂ extraction plants in fisheries near the port). Some difficulties might be related to the international nature of the subject, since aerial emissions require the involvement of multiple stakeholders that can be located worldwide and subject to different legal systems and jurisdictions; however, since the last decades, there is a general tendency to cooperate across the world in order to improve Earth's environmental conditions, and this is demonstrated by the ever-increasing number of international treaties.

8. Conclusions

The last decades have been characterized by a significant increase in world population, associated with a globalized development of industrial production and a rising transport demand for passengers and goods. Maritime transportation allows to transport large

amounts of goods across the globe with relatively low expenses, and is often used to move heavy goods around the world such as containers or heavy ore. Its effects on the environment comprehend a negative impact caused by polluting emissions (CAC, GHG, other air pollutants), generated not only by ships but also from the correlated marine infrastructure such as ports. Indeed, emissions in ports are generated by maneuvering and hoteling ships, onshore operations using energy for cranes and other devices, port vehicle traffic (internal and in/out) due to cars and trucks, facility-related systems such as lighting and HVAC, and so on. Main approaches to tackle the emission problem tend to both mitigate the cause and adapt to the existing consequences, the first done by trying to reduce the quantity of emissions in the atmosphere, the latter trying to minimize the consequences of emissions and to exploit gases such as CO₂ for commercial purposes. Estimating emissions in ports can be tricky due to the multitude of co-existing sources and the presence of surrounding interacting entities such as highways and cities; technology comes however in hand, allowing to detect and monitor emission levels with sensors and recently even drones, along with sophisticated computer algorithms. Technical devices such as scrubbers allow the treatment of emissions, whereas Cold Ironing and smart networks allow an optimized use of energy. From the governance side, many efforts have been put in the last decades from several worldwide Countries, implementing international treaties and regulations, setting up threshold levels and good practice indications. Future research can be directed towards this multitude of aspects, especially in our modern era characterized by an ever-growing environmental awareness.

Author Contributions: All authors equally contributed to the present research and to the preparation of the paper. All authors have read and agreed to the published version of the manuscript.

Funding: This research received no external funding.

Data Availability Statement: All data in this study are available in the documents referenced in bibliography.

Acknowledgments: There are no acknowledgments.

Conflicts of Interest: Authors declare no conflict of interest.

References

1. Sardain, A.; Sardain, E.; Leung, B. Global Forecasts of Shipping Traffic and Biological Invasions to 2050. *Nat. Sustain.* **2019**, *2*, 274–282. [CrossRef]
2. Pape, M. Decarbonising Maritime Transport: The EU Perspective. *Eur. Parliam. Eur. Parliam. Res. Serv. (EPRS)* **2020**. Available online: [https://www.europarl.europa.eu/thinktank/en/document.html?reference=EPRS_BRI\(2020\)659296](https://www.europarl.europa.eu/thinktank/en/document.html?reference=EPRS_BRI(2020)659296) (accessed on 4 August 2021).
3. Walsh, C.; Mander, S.; Larkin, A. Charting a Low Carbon Future for Shipping: A UK Perspective. *Mar. Policy* **2017**, *82*, 32–40. [CrossRef]
4. Halim, R.A.; Kirstein, L.; Merk, O.; Martinez, L.M. Decarbonization Pathways for International Maritime Transport: A Model-Based Policy Impact Assessment. *Sustainability* **2018**, *10*, 2243. [CrossRef]
5. Marino, L.; Pratelli, A.; Benenati, S.; Farina, A. A New Platform for the Management of Physical and Documental Flows at Italian and French Ligurian Ports. In Proceedings of the 2019 IEEE International Conference on Environment and Electrical Engineering and 2019 IEEE Industrial and Commercial Power Systems Europe (EEEIC/I&CPS Europe), Genova, Italy, 11–14 June 2019; pp. 1–7. [CrossRef]
6. Walker, T.; Adebambo, O.; Feijoo, M.; Elhaimer, E.; Hossain, T.; Edwards, S.; Morrison, C.; Romo, J.; Sharma, N.; Taylor, S.; et al. Environmental Effects of Marine Transportation. In *World Seas: An Environmental Evaluation*, 2nd ed.; Ecological Issues and Environmental Impacts; Elsevier Ltd.: Amsterdam, The Netherlands, 2019; Volume III, Chapter 27; pp. 505–530. [CrossRef]
7. Chen, J.; Fei, Y.; Wan, Z. The relationship between the development of global maritime fleets and GHG emissions from shipping. *J. Environ. Manag.* **2019**, *242*, 31–39. [CrossRef]
8. ESPO. *Environmental Code of Practice*; European Sea Ports Organization: Bruxelles, Belgium, 2004. Available online: <http://www.espo.be/publications/espo-environmental-code-of-practice> (accessed on 6 August 2021).
9. Covic Bajramajic, M.; Jelic-Mrcelic, G.; Belamaric, G.; Peric, T. Environmental Protection and Sustainable Ports. In Proceedings of the ICTS–19th International Conference on Transport Science, Portoroz, Slovenia, 17–18 September 2020.

10. ESPO. Green Guide. In *Toward Excellence in Port Environmental Management and Sustainability*; ESPO—European Sea Ports Organization: Espo, Finland, 2012; p. 7. Available online: <https://www.espo.be/publications/espo-green-guide-towards-excellence-in-port-enviro> (accessed on 6 August 2021).
11. ESPO. *Environmental Report 2020 Eco Ports in Sight*; ESPO: Espo, Finland, 2020.
12. Joung, T.H.; Kang, S.G.; Lee, J.K.; Ahn, J. The IMO Initial Strategy for Reducing Greenhouse Gas (GHG) Emissions, and Its Follow-Up Actions towards 2050. *J. Int. Marit. Saf. Environ. Aff. Shipp.* **2020**, *4*, 1–7. [[CrossRef](#)]
13. International Maritime Organization. *Fourth IMO Greenhouse Gas Study 2020*; International Maritime Organization: London, UK, 2020; Published in 2021 by the International Maritime Organization, 4 Albert Embankment, London (UK) SE1 7SR; Available online: www.imo.org (accessed on 6 August 2021).
14. Chircop, A. The IMO Initial Strategy for the Reduction of GHGs from International Shipping; a Commentary. *Int. J. Mar. Coast. Law* **2020**, *34*, 482–512. [[CrossRef](#)]
15. Repka, S.; Erkkila-Valimaki, A.; Eiof Jonson, J.; Posch, M.; Torronen, J.; Jalkanen, J.P. Assessing the Costs and Environmental Benefits of IMO Regulations of Ship-Originated SO_x and NO_x Emissions in the Baltic Sea. *Ambio* **2021**, *50*, 1718–1730. [[CrossRef](#)] [[PubMed](#)]
16. Nunes, R.A.O.; Alvim-Ferraz, M.C.M.; Martins, F.G.; Sousa, S.I.V. The Activity-Based Methodology to Assess Ship Emissions—A Review. *Environ. Pollut.* **2017**, *231*, 87–103. [[CrossRef](#)] [[PubMed](#)]
17. Van Fan, Y.; Perry, S.; Klemes, J.J.; Lee, C.T. A Review on Air Emissions Assessment: Transportation. *J. Clean. Prod.* **2018**, *194*, 673–684. [[CrossRef](#)]
18. Zelenko, Y.; Zelenko, D.; Neduzha, L. Contemporary Principles for Solving the Problem in Noise Reduction from Railway Rolling Stock. *IOP Conf. Ser. Mater. Sci. Eng.* **2020**, *985*, 012015. [[CrossRef](#)]
19. Kweku Darkwah, W.; Odum, B.; Addae, M.; Koomson, D.; Kwakye Danso, B.; Oti-Mensah, E.; Quachie Asenso, T.; Adormaa Buanya, B. Greenhouse Effect: Greenhouse Gases and Their Impact on Global Warming. *J. Sci. Res. Rep.* **2018**, 1–9. [[CrossRef](#)]
20. Gan, J.; Li, L.; Xiang, Q.; Ran, B. A Prediction Method of GHG Emissions for Urban Road Transportation Planning and Its Applications. *Sustainability* **2020**, *12*, 10251. [[CrossRef](#)]
21. AlKheder, S. Promoting Public Transport as a Strategy to Reduce GHG Emissions from Private Vehicles in Kuwait. *Environ. Chall.* **2021**, *3*, 100075. [[CrossRef](#)]
22. Psaraftis, H.N.; Kontovas, C.A. Decarbonization of Maritime Transport: Is There Light at the End of the Tunnel? *Sustainability* **2021**, *13*, 237. [[CrossRef](#)]
23. Liou, J.L.; Wu, P.I. Monetary Health Co-Benefits and GHG Emissions Reduction Benefits: Contribution from Private On-the-Road Transport. *Int. J. Environ. Res. Public Health* **2021**, *18*, 5537. [[CrossRef](#)]
24. Cassia, R.; Nocioni, M.; Correa-Aragunde, N.; Lamattina, L. Climate Change and the Impact of Greenhouse Gases: CO₂ and NO_x, Friends and Foes of Plant Oxidative Stress. *Front. Plant Sci.* **2018**, *9*, 273. [[CrossRef](#)]
25. Fridell, E. Chapter 2-Emissions and Fuel Use in the Shipping Sector. *Green Ports* **2019**, 19–33. [[CrossRef](#)]
26. Zis, T.P.V.; Cullinane, K. The Desulphurization of Shipping: Past, Present and the Future under a Global Cap. *Transp. Res. Part. D* **2020**, *82*. [[CrossRef](#)]
27. Lou, H.; Hao, Y.; Zhang, W.; Su, P.; Zhang, F.; Chen, Y.; Feng, D.; Li, Y. Emissions of Intermediate Volatility Organic Compounds from a Ship Main Engine Burning Heavy Fuel Oil. *J. Environ. Sci.* **2019**, *84*, 197–204. [[CrossRef](#)] [[PubMed](#)]
28. Zhu, H.; Wang, H.; Jing, S.; Wang, Y.; Cheng, T.; Tao, S.; Lou, S.; Qiao, L.; Li, L.; Chen, J. Characteristics and Sources of Atmospheric Volatile Organic Compounds (VOCs) Along the Mid-Lower Yangtze River in China. *Atmos. Environ.* **2018**, *190*, 232–240. [[CrossRef](#)]
29. Lin, H.; Tao, J.; Qian, Z.M.; Ruan, Z.; Xu, Y.; Hang, J.; Xu, X.; Liu, T.; Guo, Y.; Zeng, W.; et al. Shipping Pollution Emission Associated with Increased Cardiovascular Mortality: A Time Series Study in Guangzhou, China. *Environ. Pollut.* **2018**, *241*, 862–868. [[CrossRef](#)]
30. Grennfelt, P.; Engleryd, A.; Forsius, M.; Hov, O.; Rodhe, H.; Cowling, E. Acid Rain and Air Pollution: 50 Years of Progress in Environmental Science and Policy. *Ambio* **2019**, *49*, 849–864. [[CrossRef](#)]
31. Lubinski, W. *Military Physician*; Military Institute of Medicine: Warsaw, Poland, 2017.
32. Soni, V.; Singh, P.; Shree, V.; Goel, V. Effects of VOCs on Human Health. *Air Pollut. Control.* **2018**, 119–142. [[CrossRef](#)]
33. Kowalska, M.; Skrzypek, M.; Kowalski, M.; Cyrus, J. Effect of NO_x and NO₂ Concentration Increase in Ambient Air to Daily Bronchitis and Asthma Exacerbation, Silesian Voivodeship in Poland. *Int. J. Environ. Res. Public Health* **2020**, *17*, 754. [[CrossRef](#)] [[PubMed](#)]
34. Jonson, J.E.; Borcken-Kleefeld, J.; Simpson, D.; Nyiri, A.; Posch, M.; Heyes, C. Impact of Excess NO_x Emissions from Diesel Cars on Air Quality, Public Health and Eutrophication in Europe. *Environ. Res. Lett.* **2017**, *12*, 094017. [[CrossRef](#)]
35. Kodavanti, U.P. Stretching the stress boundary: Linking air pollution health effects to a neurohormonal stress response. *Biochim. Biophys. Acta (BBA) Gen. Sub.* **2016**, *1860*, 2880–2890. [[CrossRef](#)] [[PubMed](#)]
36. Woo, J.K.; Moon, D.S.H.; Siu Lee Ham, J. The Impact of Environmental Policy on Ports and the Associated Economic Opportunities. *Transp. Res. Part. A Policy Pract.* **2018**, *110*, 234–242. [[CrossRef](#)]
37. Zanne, M.; Twrdy, E. The Economic Analysis of Air Pollution Mitigation Measures in Smaller Ports. *RFDS* **2021**, *33*, 145–152. [[CrossRef](#)]
38. Ksiazkiewicz, D. Clean Air Policy in European Marine Ports. *Sci. Pap. Sil. Univ. Technol.* **2020**, *149*, 371–381. [[CrossRef](#)]

39. Zhu, S.; Sun, J.; Liu, Y.; Lu, M.; Liu, X. The Air Quality Index Trend Forecasting based on Improved Error Correction Model and Data Preprocessing for 17 Port Cities in China. *Chemosphere* **2020**, *252*. [CrossRef]
40. Gobbi, G.P.; Di Liberto, L.; Barnaba, F. Impact of Port Emissions on EU-regulated and Non-regulated Air Quality Indicators: The Case of Civitavecchia (Italy). *Sci. Total. Environ.* **2020**, *719*. [CrossRef] [PubMed]
41. Toscano, D.; Murena, F. Atmospheric Emissions in Ports: A Review. Correlation with Data of Ship Traffic. *Atmos. Environ. X* **2019**, *4*. [CrossRef]
42. Shen, L.; Wang, Y.; Liu, K.; Yang, Z.; Shi, X.; Yang, X.; Jing, K. Synergistic Path Planning of Multi-UAVs for Air Pollution Detection of Ships in Ports. *Transp. Res. Part. E* **2020**, *144*. [CrossRef]
43. Karakikes, I.; Hofmann, W.; Mitropoulos, M.; Savrasovs, M. Evaluation of Freight Measures by Integrating Simulation Tools: The Case of Volos Port, Greece. *Transport Telecommun. J.* **2018**, *19*, 224–232. [CrossRef]
44. Gonzalez-Aregall, M.; Bergqvist, R. Green Port Initiatives for a More Sustainable Port-City Interaction: The Case Study of Barcelona. *Marit. Transp. Reg. Sustain.* **2020**, *7*, 109–132. [CrossRef]
45. Merico, E.; Dinoi, A.; Contini, D. Development of an Integrated Modelling-Measurement System for Near-Real-Time Estimates of Harbor Activity Impact to the Atmospheric Pollution in Coastal Cities. *Transp. Res. Part. D* **2019**, *73*, 108–119. [CrossRef]
46. Progiou, A.G.; Bakeas, E.; Evangelidou, E.; Kontogiorgi, G.; Lagkadinou, E.; Sebos, I. Air Pollutant Emissions from Piraeus port: External Costs and Air Quality Levels. *Transp. Res. Part. D Transport Environ.* **2021**, *91*. [CrossRef]
47. *EMEP/EEA Air Pollutant Emission Inventory Guidebook 2019*; EEA (European Environment Agency), Publications Office of the European Union: Luxembourg, 2019.
48. Handbook on External Costs of Transport—European Commission. *Directorate-General for Mobility and Transport 2019*; Publications Office of the European Union: Luxembourg, 2019. [CrossRef]
49. Martinez-Moya, J.; Vazquez-Paja, B.; Jimenez Maldonado, J.A. Energy Efficiency and CO₂ Emissions of Port Container Terminal Equipment: Evidence from the Port of Valencia. *Energy Policy* **2019**, *131*, 312–319. [CrossRef]
50. Bordianu, A.; Samoilescu, G. Electric and Hybrid Propulsion in the Naval Industry. In Proceedings of the 2019 11th International Symposium on Advanced Topics in Electrical Engineering (ATEE), Bucharest, Romania, 28–30 March 2019. [CrossRef]
51. Elgohary, M.M.; Seediq, I.S.; Al-Baity, O. Design Consideration and Eco-Environmental Assessment for Electric Propulsion Ships: Case Study—Cruise ship. In Proceedings of the IEK 27th International Annual Conference, Mombasa, Kenya, 24–27 November 2020.
52. Sui, C.; De Vos, P.; Stapersma, D.; Visser, K.; Ding, Y. Fuel Consumption and Emissions of Ocean-Going Cargo Ship with Hybrid Propulsion and Different Fuels over Voyage. *J. Mar. Sci. Eng.* **2020**, *8*, 588. [CrossRef]
53. Geertsma, R.D.; Negenborn, N.N.; Visser, K.; Hopman, J.J. Design and Control of Hybrid Power and Propulsion Systems for Smart Ships: A Review of Developments. *Appl. Energy* **2017**, *194*, 30–54. [CrossRef]
54. IRENA. *Navigating to a Renewable Future: Solutions for Decarbonizing Shipping*; Preliminary Findings; International Renewable Energy: Abu Dhabi, United Arab Emirates, 2019.
55. Byeong-Yong, Y. Economic Assessment of Liquefied Natural Gas (LNG) as a Marine Fuel for CO₂ Carriers Compared to Marine Gas Oil (MGO). *Energy* **2017**, *121*, 772–780. [CrossRef]
56. Pfoser, S.; Schauer, O.; Costa, Y. Acceptance of LNG as an Alternative Fuel: Determinants and Policy Implications. *Energy Policy* **2018**, *120*, 259–267. [CrossRef]
57. Iannacone, T.; Landucci, G.; Tugnoli, A.; Salzano, E.; Cozzani, V. Sustainability of Cruise Ship Fuel Systems: Comparison among LNG and Diesel Technologies. *J. Clean. Prod.* **2020**, *260*, 121069. [CrossRef]
58. Pavlenko, N.; Comer, B.; Zhou, Y.; Clark, N.; Rutherford, D. *The Climate Implications of Using LNG as a Marine Fuel—2020 International Council on Clean Transportation (ICCT), Working Paper 2020-02*; ICCT Online Publication: Berlin, Germany, 2020.
59. United Nations Framework Convention on Climate Change (UNFCCC). Shipping, World Trade and the Reduction of CO₂ Emissions. International Chamber of Shipping (ICS), London EC3A 8BH (UK). 2014. Available online: <https://www.sciencedirect.com/science/article/pii/S258900422030955X> (accessed on 6 August 2021).
60. Viana, M.; Rizza, V.; Tobias, A.; Carr, E.; Corbett, J.; Sofiev, M.; Karanasiou, A.; Buonanno, G.; Fann, N. Estimated Health Impacts from Maritime Transport in the Mediterranean Region and Benefits from The Use of Cleaner Fuels. *Environ. Int.* **2020**, *138*. [CrossRef] [PubMed]
61. Mukherjee, A.; Bruijninx, P.; Junginger, M. A Perspective on Biofuels Use and CCS for GHG Mitigation in the Marine Sector. *iScience* **2020**, *23*. [CrossRef] [PubMed]
62. Sonthalia, A.; Kumar, N. Hydroprocessed Vegetable Oil as a Fuel for Transportation Sector: A Review. *J. Energy Inst.* **2019**, *92*, 1–17. [CrossRef]
63. Sunnu, A.K.; Ayetor, G.K.; Gaye, J.M. Straight Vegetable Oil Fuel Performance and Exhaust Emissions under Turbocharged and Naturally Aspirated Conditions. *Energy Sources Part. A Recovery Util. Environ. Eff.* **2019**. [CrossRef]
64. Mat, S.C.; Idroas, M.Y.; Hamid, M.F.; Zainal, Z.A. Performance and Emissions of Straight Vegetable Oils and Its Blends as a Fuel in Diesel Engine: A Review. *Renew. Sustain. Energy Rev.* **2018**, *82*, 808–823. [CrossRef]
65. Dimitriadis, A.; Natsios, I.; Dimaratos, A.; Katsaounis, D.; Samaras, Z.; Bezergianni, S.; Lehto, K. Evaluation of a Hydrotreated Vegetable Oil (HVO) and Effects on Emissions of a Passenger Car Diesel Engine. *Front. Mech. Eng.* **2018**. [CrossRef]
66. Rimkus, A.; Zaglinskis, J.; Stravinskas, S.; Rapalis, P.; Matijosius, J.; Berezky, A. Research on the Combustion, Energy and Emission Parameters of Various Concentration Blends of Hydrotreated Vegetable Oil Biofuel and Diesel Fuel in a Compression-Ignition Engine. *Energies* **2019**, *12*, 2978. [CrossRef]

67. Shi, J.; Wang, T.; Zhao, Z.; Wu, Z.; Zhang, Z. Cycle to Cycle Variation of a Diesel Engine Fueled with Fischer-Tropsch Fuel Synthesized from Coal. *Appl. Sci.* **2019**, *9*, 2032. [CrossRef]
68. Zang, G.; Sun, P.; Elgowainy, A.A.; Bafana, A.; Wang, M. Performance and Cost Analysis of Liquid Fuel Production from H₂ and CO₂ based on The Fischer-Tropsch Process. *J. CO₂ Util.* **2021**, *46*, 101459. [CrossRef]
69. Mohanty, S.K.; Swain, M. Chapter 3–Bioethanol Production from Corn and Wheat: Food, Fuel, and Future. *Bioethanol. Prod. Food Crop.* **2019**, 45–99. [CrossRef]
70. Jiao, J.; Li, J.; Bai, Y. Ethanol as a Vehicle Fuel in China: A Review from the Perspectives of Raw Material Resource, Vehicle, and Infrastructure. *J. Clean. Prod.* **2018**, *180*, 832–845. [CrossRef]
71. Paulauskiene, T.; Bucas, M.; Laukinaite, A. Alternative Fuels for Marine Applications: Biomethanol-Biodiesel-Diesel Blends. *Fuel* **2019**, *248*, 161–167. [CrossRef]
72. Wang, Z.; Paulauskiene, T.; Uebe, J.; Bucas, M. Characterization of Biomethanol-Biodiesel-Diesel Blends as Alternative Fuel for Marine Applications. *J. Mar. Sci. Eng.* **2020**, *8*, 730. [CrossRef]
73. Chen, H.; He, J.; Chen, Z.; Geng, L. A Comparative Study of Combustion and Emission Characteristics of Dual-Fuel Engine Fueled with Diesel/Methanol and Diesel-Polyoxymethylene Dimethyl Ether Blend/Methanol. *Process. Saf. Environ. Prot.* **2021**, *147*, 714–722. [CrossRef]
74. Lin, Q.; Tay, K.L.; Yu, W.; Zong, Y.; Yang, W.; Rivellini, L.H.; Ma, M.; King Yin Lee, A. Polyoxymethylene Dimethyl Ether 3 (PODE3) as an Alternative Fuel to Reduce Aerosol Pollution. *J. Clean. Prod.* **2021**, *285*, 124857. [CrossRef]
75. Oumer, A.N.; Hasan, M.M.; Baheta, A.T.; Mamat, R.; Abdullah, A.A. Bio-based Liquid Fuels as a Source of Renewable Energy: A Review. *Renew. Sustain. Energy Rev.* **2018**, *88*, 82–98. [CrossRef]
76. Kesime, U.; Pazouki, K.; Murphy, A.; Chrysanthou, A. Biofuel as an Alternative Shipping Fuel: Technological, Environmental and Economic Assessment. *Sustain. Energy Fuels* **2019**. [CrossRef]
77. Maggioni, L. Bio-LNG on its way forward: Case Italy. In Proceedings of the European Biomethane Conference, Berlin, Germany, 2007; Available online: <https://onlinelibrary.wiley.com/doi/abs/10.1002/adma.201805173> (accessed on 6 August 2021).
78. Shanmugam, K.; Tysklind, M.; Upadhyayula, V.K.K. Use of Liquefied Biomethane (LBM) as a Vehicle Fuel for Road Freight Transportation: A Case Study Evaluating Environmental Performance of Using LBM for Operation of Tractor Trailers. *Procedia CIRP* **2018**, *69*, 517–522. [CrossRef]
79. Feng, J.; Xu, B. Electrochemical Ammonia Synthesis and Ammonia Fuel Cells. *Adv. Mater.* **2018**, 1805173. [CrossRef]
80. Yapicioglu, A.; Dincer, I. A Review on Clean Ammonia as a Potential Fuel for Power Generators. *Renew. Sustain. Energy Rev.* **2019**, *103*, 96–108. [CrossRef]
81. Bicer, Y.; Dincer, I. Environmental Impact Categories of Hydrogen and Ammonia Driven Transoceanic Vehicles: A Comparative Evaluation. *Int. J. Hydrog. Energy* **2018**, *43*, 4583–4596. [CrossRef]
82. Manoharan, Y.; Hosseini, S.E.; Butler, B.; Alzahrani, H.; Senior, B.T.F.; Ashuri, T.; Krohn, J. Hydrogen Fuel Cell Vehicles; Current Status and Future Prospect. *Appl. Sci.* **2019**, *9*, 2296. [CrossRef]
83. Tanc, B.; Arat, H.T.; Baltacioglu, E.; Aydin, K. Overview of the Next Quarter Century Vision of Hydrogen Fuel Cell Electric Vehicles. *Int. J. Hydrog. Energy* **2019**, *44*, 10120–10128. [CrossRef]
84. Awoyomi, A.; Patchigolla, K.; Anthony, E.J. CO₂/SO₂ Emission Reduction in CO₂ Shipping Infrastructure. *Int. J. Greenh. Gas. Control.* **2019**, *88*, 57–70. [CrossRef]
85. Awoyomi, A.; Patchigolla, K.; Anthony, E.J. Process and Economic Evaluation of an Onboard Capture System for LNG-Fueled CO₂ Carriers. *Ind. Eng. Chem. Res.* **2020**, *59*, 6951–6960. [CrossRef]
86. Feenstra, M.; Monteiro, J.; Van Den Akker, J.T.; Abu-Zahra, M.R.M.; Gilling, E.; Goetheer, E. Ship-based Carbon Capture Onboard of Diesel or LNG-fueled Ships. *Int. J. Greenh. Gas. Control.* **2019**, *85*, 1–10. [CrossRef]
87. Lehtoranta, K.; Aakko-Saksa, P.; Murtonen, T.; Vesala, H.; Ntziachristos, L.; Ronkko, T.; Karjalainen, P.; Kuittinen, N.; Timonen, H. Particulate Mass and Nonvolatile Particle Number Emissions from Marine Engines Using Low-Sulfur Fuels, Natural Gas, or Scrubbers. *Environ. Sci. Technol.* **2019**, *53*, 3315–3322. [CrossRef] [PubMed]
88. Comer, B.; Georgeff, E.; Osipova, L. *Air Emissions and Water Pollution Discharges from Ships with Scrubbers. ICCT (International Council on Clean Transportation) Consulting Report*; ICCT Online Publication: Berlin, Germany, 2020.
89. Bolbot, V.; Theotokatos, G.; Boulougouris, E.; Psarros, G.; Hamann, R. A Novel Method for Safety Analysis of Cyber-Physical Systems—Application to a Ship Exhaust Gas Scrubber System. *Safety* **2020**, *6*, 26. [CrossRef]
90. Misra, A.; Venkataramani, G.; Gowrishankar, S.; Ayyasam, E.; Ramalingam, V. Renewable Energy Based Smart Microgrids—A Pathway to Green Port Development. *Strateg. Plan. Energy Environ.* **2017**, *37*, 17–32. [CrossRef]
91. Rezaei, M.; Mostafaeipour, A.; Qolipour, M.; Arabia, H.R. Hydrogen Production using Wind Energy from Sea Water: A Case Study on Southern and Northern Coasts of Iran. *Energy Environ.* **2018**, *29*, 333–357. [CrossRef]
92. Sadek, I.; Elgohary, M. Assessment of Renewable Energy Supply for Green Ports with a Case Study. *Environ. Sci. Pollut. Res.* **2020**, *27*, 5547–5558. [CrossRef] [PubMed]
93. Seddiek, I.S. Application of Renewable Energy Technologies for Eco-Friendly Sea Ports. *Ships Offshore Struct.* **2019**, *15*, 953–962. [CrossRef]
94. Fossile, D.K.; Frej, E.A.; Gouvea da Costa, S.; Pinheiro de Lima, E.; Teixeira de Almeida, A. Selecting the Most Viable Renewable Energy Source for Brazilian Ports using the FITradeoff Method. *J. Clean. Prod.* **2020**, *260*, 121107. [CrossRef]

95. Hentschel, M.; Ketter, W.; Collins, J. Renewable Energy Cooperatives: Facilitating the Energy Transition at the Port of Rotterdam. *Energy Policy* **2018**, *121*, 61–69. [CrossRef]
96. Balcombe, P.; Brierley, J.; Lewis, C.; Skatvedt, L.; Speirs, J.; Hawkes, A.; Staffell, I. How to decarbonize international shipping: Options for fuels, technologies and policies. *En. Con. Man.* **2019**, *182*, 72–88. [CrossRef]
97. Banaei, M.; Boudjadar, J.; Khooban, M.H. Stochastic Model Predictive Energy Management in Hybrid Emission-Free Modern Maritime Vessels. *IEEE Trans. Ind. Inform.* **2021**, *17*, 5430–5440. [CrossRef]
98. Yuan, Y.; Zhang, T.; Shen, B.; Yan, X.; Long, T. A Fuzzy Logic Energy Management Strategy for a Photovoltaic/Diesel/Battery Hybrid Ship Based on Experimental Database. *Energies* **2018**, *11*, 2211. [CrossRef]
99. Zhang, Z.; Guan, C.; Liu, Z. Real-Time Optimization Energy Management Strategy for Fuel Cell Hybrid Ships Considering Power Sources Degradation. *IEEE Access* **2020**, *8*, 87046–87059. [CrossRef]
100. Cetin, O.; Ziya Sogut, M. A New Strategic Approach of Energy Management Onboard Ships Supported by Exergy and Economic Criteria: A Case Study of a Cargo Ship. *Ocean. Eng.* **2019**, *219*, 108137. [CrossRef]
101. Baldi, F.; Marechal, F.; Tammi, K. Process Integration as a Tool for the Improvement of Cruise Ships Energy Efficiency. In Proceedings of the Conference: Shipping in Changing Climates, London, UK, 2017. Available online: <https://onlinelibrary.wiley.com/doi/abs/10.1002/er.4062> (accessed on 6 August 2021).
102. Suarez de la Fuente, S.; Roberge, D.; Greig, A.R. Safety and CO₂ emissions: Implications of using organic fluids in a ship's waste heat recovery system. *Mar. Policy* **2017**, *75*, 191–203. [CrossRef]
103. Yigit, K.; Acarkan, B. A New Ship Energy Management Algorithm to the Smart Electricity Grid System. *Int. J. Energy Res.* **2018**, *42*, 2741–2756. [CrossRef]
104. Amjad, Z.; Shah, M.A.; Maple, C.; Khattak, H.A.; Ameer, Z.; Asghar, M.N.; Mussadiq, S. Towards Energy Efficient Smart Grids Using Bio-Inspired Scheduling Techniques. *IEEE Access* **2020**, *8*, 158947–158960. [CrossRef]
105. Geerlings, H.; Heji, R.; Van Duin, R. Opportunities for Peak Shaving the Energy Demand of Ship-to-Shore Quay Cranes at Container Terminals. *J. Shipp. Trd.* **2018**, *3*, 3. [CrossRef]
106. Prousalidis, J.; Lyridis, D.; Dallas, S.; Soghomonian, Z.; Georgiou, V.; Spathis, D.; Kourmpelis, T.; Mitrou, P. Ship to Shore Electric Interconnection: From Adolescence to Maturity. *IEEE Electr. Ship Technol. Symp.* **2017**, 200–206. [CrossRef]
107. Binti Ahamad, N.B.; Guerrero, J.M.; Su, C.L.; Vasquez, J.C.; Zhaoxia, X. Microgrids Technologies in Future Seaports. In Proceedings of the 2018 IEEE International Conference on Environment and Electrical Engineering and 2018 IEEE Industrial and Commercial Power Systems Europe (EEEIC/I&CPS Europe), Palermo, Italy, 12–15 June 2018; pp. 1–6. [CrossRef]
108. Monacelli, N. Applying Cold-Ironing Regulation in Southeast Asian Ports to Reduce Emissions. *Asia-Pac. J. Ocean. Law Policy* **2017**, *2*, 296–316. [CrossRef]
109. Lind, M.; Bjorn-Andersen, N.; Watson, R.; Ward, R.; Bergmann, M.; Rylander, R.; Andersen, T.; Hagg, M.; Karlsson, M.; Zerem, A.; et al. The Potential Role of PortCDM in Cold Ironing. Sea Traffic Management (STM). Report number: Concept Note #20, Affiliation: RISE Research Institutes of Sweden, October 2018. Sea Traffic Management (STM), Published in cooperation with Fathom.World; Co-financed by the European Union. Available online: https://www.researchgate.net/profile/Enrico-Mancinelli/publication/329119053_A_cogeneration_power_plant_to_integrate_cold_ironing_and_district_heating_and_cooling/links/5bfbcde5458515a69e3beaf5/A-cogeneration-power-plant-to-integrate-cold-ironing-and-district-heating-and-cooling.pdf (accessed on 6 August 2021).
110. Zis, T.P.V. Green Ports. In *Sustainable Shipping: A Cross-Disciplinary View Chapter 12*; Psaraftis, H.N., Ed.; Springer Nature: Cham, Switzerland, 2019; pp. 407–432. ISBN 978-3-030-04329-2.
111. Esposito, F.; Mancinelli, E.; Morichetti, M.; Passerini, G.; Rizza, U. A Cogeneration Power Plant to Integrate Cold Ironing and District Heating and Cooling. *Int. J. Energy Prod. Manag.* **2018**, *3*, 214–225. [CrossRef]
112. Zis, T.P.V. Prospects of Cold Ironing as an Emissions Reduction Option. *Transp. Res. Part. A* **2019**, *119*, 82–95. [CrossRef]
113. Rolan, A.; Manteca, P.; Oktar, R.; Siano, P. Integration of Cold Ironing and Renewable Sources in the Barcelona Smart Port. *IEEE Trans. Ind. Appl.* **2019**, *5*, 7198–7206. [CrossRef]
114. Kotrikla, A.M.; Lilas, T.; Nikitakos, N. Abatement of Air Pollution at an Aegean Island Port Utilizing Shore Side Electricity and Renewable Energy. *Mar. Policy* **2018**, *75*, 238–248. [CrossRef]
115. Reusser, C.A.; Perez, J.R. Evaluation of the Emission Impact of Cold-Ironing Power Systems, Using a Bi-Directional Power Flow Control Strategy. *Sustainability* **2021**, *13*, 334. [CrossRef]
116. Kilic, A.; Yolcu, M.; Kilic, F.; Bilgili, L. Assessment of Ship Emissions through Cold Ironing Method for Iskendrum Port of Turkey. *Environ. Res. Technol.* **2020**, *3*, 193–201.
117. Martinez Lopez, A.; Romero-Filgueira, A.; Chica, M. Specific Environmental Charges to boost Cold Ironing use in the European Short Sea Shipping. *Transp. Res. Part. D Transport. Environ.* **2021**, *94*, 102775. [CrossRef]
118. Chen, J.; Zheng, T.; Garg, A.; Xu, L.; Li, S.; Fei, Y. Alternative Maritime Power Application as a Green Port Strategy: Barriers in China. *J. Clean. Prod.* **2018**, *213*, 825–837. [CrossRef]
119. Paulauskas, V.; Filina-Dawidowicz, L.; Paulaskas, D. The Method to Decrease Emissions from Ships in Port Areas. *Sustainability* **2020**, *12*, 4374. [CrossRef]
120. Vojkovic, G.; Milenkovic, M. Autonomous Ships and Legal Authorities of the Ship Master. *Case Stud. Transport. Policy* **2020**, *8*, 333–340. [CrossRef]

121. Ait Allal, A.; Mansouri, K.; Youssfi, M.; Qbadou, M. toward Energy Saving and Environmental Protection by Implementation of Autonomous Ship. In Proceedings of the 19th IEEE Mediterranean Electrotechnical Conference (MELECON), Marrakech, Morocco, 2–7 May 2018; pp. 177–180. [[CrossRef](#)]
122. Rodseth, O.J.; Froystad, C.; Meland, P.H.; Bernsmed, K.; Nesheim, D.A. The Need for a Public Key Infrastructure for Automated and Autonomous Ships. *IOP Conf. Ser. Mater. Sci. Eng.* **2020**, *929*, 012017. [[CrossRef](#)]
123. Mao, X.; Rutherford, D.; Osipova, L.; Comer, B. *Refueling Assessment of a Zero-Emission Container Corridor between China and the United States: Could Hydrogen Replace Fossil Fuels?* Working Paper; ICCT Online Publication: Berlin, Germany, 2020.
124. Wood, G.; Baker, K. Ports. In *The Palgrave Handbook of Managing Fossil Fuels and Energy Transitions*; Palgrave Macmillan: Cham, Switzerland, 2020; pp. 149–151.
125. Bosman, R.; Loorbach, D.; Rotmans, J.; Van Raak, R. Carbon Lock-Out: Leading the Fossil Port of Rotterdam into Transition. *Sustainability* **2018**, *10*, 2558. [[CrossRef](#)]